



CERAMIC

CERAMIC '20





Hand made in Italy

INDEX

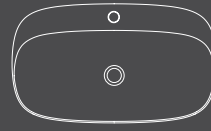
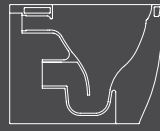

cm: 42 - 50 - 70 - 90

MOON



WC-BIDET & WASHBASINS

Pag_ 14

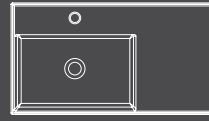

cm: 41 - 45 - 50 - 60 - 80
100 - 120 - 141

TEOREMA 2.0 ULTRASLIM



WC-BIDET & WASHBASINS

Pag_ 34



= Lavabo sospeso
Wall-mounted washbasin
Lavabo suspendu
Hängewaschbecken
Lavabo suspendido
Раковина умывальника подвесная



= Lavabo da appoggio
Lay-on washbasin
Lavabo à poser
Aufsatzwaschbecken
Lavabo de apoyo
Раковина умывальника накладная



= Lavabo da semincasso
Semi built-in washbasin
Lavabo semi encastré
Vorbauwaschbecken
Lavabo de semiencaje
Раковина умывальника полувстраиваемая



= Lavabo da incasso
Built-in washbasin
Lavabo encastré
Einbauwaschbecken
Lavabo de encaje
Раковина умывальника встраиваемая



= Lavabo sottopiano
Under-top washbasin
Lavabo encastré par dessous
Unterbauwaschbecken
Lavabo bajo encimera
Раковина умывальника под столешницу



= Lavabo a terra da appoggio
Floor-standing washbasin
Lavabo au sol
Standwaschbecken
Lavabo al suelo de apoyo
Раковина умывальника напольная



= Wc / Bidet Sospeso
Wall-mounted WC / Bidet
Cuvette / Bidet suspendu
Hänge-WC / Bidet
Inodoro / Bidet suspendido
Унитаз / Биде подвесной



= Wc / Bidet a terra
Floor-mounted WC / Bidet
Cuvette / Bidet au sol
Bodenstehendes WC / Bidet
Inodoro / Bidet a tierra
Унитаз / Биде напольное

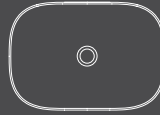

cm: 22 - 33 - 39 - 40
55 - 56 - 75 - 76 - 95

GLAM



WASHBASINS

Pag_ 76

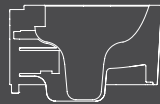

cm: 30 - 35 - 40 - 42 - 50

BUCKET



WC-BIDET & WASHBASINS

Pag_ 94

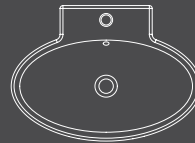
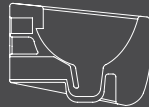

cm: 45 - 48 - 54 - 66

PLANET



WC-BIDET & WASHBASINS

Pag_ 119

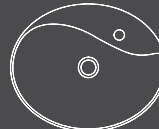

cm: 51 - 55 - 71

MOAI



WC-BIDET & WASHBASINS

Pag_ 135

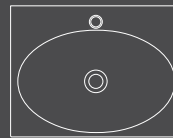

cm: 46 - 60

VEIL



WASHBASINS

Pag_ 145

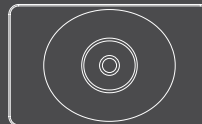

cm: 50 - 70 - 80

FUJI



WASHBASINS

Pag_ 155

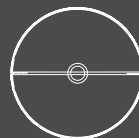

cm: 45 - 70

MIZU®



WASHBASINS

Pag_ 169



SOFT - HUNG - CUBE



cm: 24 - 30 - 38 - 40
42 - 45 - 50 - 60

WASHBASINS
Pag _ 181

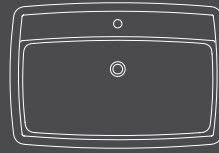

ARCO



cm: 60 - 80

WASHBASINS
Pag _ 289

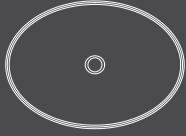

THIN-LINE



cm: 40 - 45 - 55 - 63

WASHBASINS
Pag _ 195

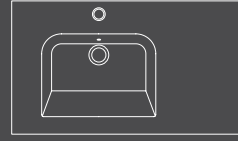

ETRA



cm: 61 - 82

WASHBASINS
Pag _ 295

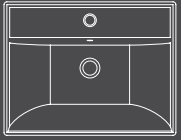

ML



cm: 60 - 92 - 122

WASHBASINS
Pag _ 215



SEVENTY



cm: 41 - 55

WASHBASINS
Pag _ 303

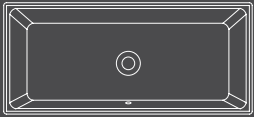

GAIA - TECH - MIKY



cm: 42 - 47 - 57 - 87

WASHBASINS
Pag _ 227

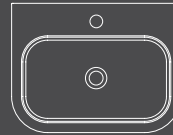

NEXT



cm: 41 - 60 - 81

WASHBASINS
Pag _ 307

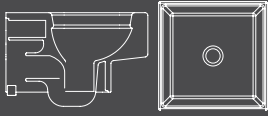

TEOREMA



cm: 30 - 40 - 46 - 60 - 80
100 - 120

WC-BIDET & WASHBASINS
Pag _ 234



SHAPE



cm: 45 - 70

WASHBASINS
Pag _ 317



MATTY



cm: 46 - 64

WASHBASINS
Pag _ 253

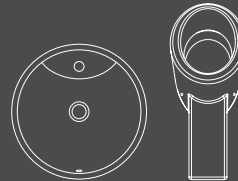

LAVABI D'ARREDO



cm: 30 - 37 - 40 - 48 - 87

WASHBASINS & URINAL
Pag _ 323



KONG



cm: 48 - 72 - 90 - 109

WASHBASINS
Pag _ 265

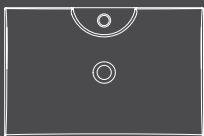

TSUNAMI



cm: 70 - 90

WASHBASINS
Pag _ 275

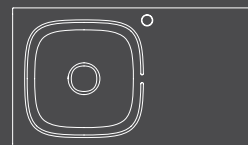

UP



cm: 86

KITCHEN SINK
Pag _ 335

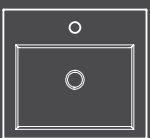

SQUARE



cm: 47 - 51 - 60

WASHBASINS
Pag _ 281

ACCESSORIES

ACCESSORI - ACCESSOIRES - ZUBEHÖR - ACCESORIOS - АКЦЕССУАРЫ
Pag _ 340

COMPANY

Scarabeo Ceramiche è un'azienda italiana specializzata nella produzione di sanitari e arredo bagno innovativi e dal design originale. Dal 1974 mette a frutto la propria capacità di dare forma alla ceramica e trasformarla in lavabi e sanitari dallo stile unico e inconfondibile conquistando nel tempo un successo di carattere internazionale che ha portato il brand a posizionarsi come un vero e proprio punto di riferimento per chi cerca idee nuove con cui arredare il bagno. Il saper interpretare il bagno offrendo design e funzionalità ha da sempre contraddistinto l'indole dell'azienda: competenza ed esperienza al servizio di una grande squadra che opera partendo da un'idea che, grazie alle infinite possibilità di lavorazione della ceramica, prende forma e si tramuta in un arredo completo, efficiente, esteticamente appagante e in grado di definire con carattere la personalità di un bagno. La continua ricerca di novità e la capacità di sapersi costantemente evolvere in accordo con le diverse esigenze manifestate dal mercato hanno permesso a Scarabeo di comporre una gamma molto ampia e sempre in crescita non solo di lavabi e sanitari ma anche di complementi di arredo ed accessori unici e di qualità impeccabile.

Scarabeo Ceramiche is an Italian company specialized in the production of innovative and original sanitary ware and bathroom furniture. Since 1974 it has been making use of its own ability to give shape to ceramic and turn it into washbasins and WCs with a unique style. This has allowed to gain over time an international success that has made the brand a real reference point for people searching new ideas for their own bathroom.

The interpretation of the bathroom by giving design and functionality has always characterized the nature of the company: competence and expertise in the service of a great team acting by starting from an idea which, thanks to the unlimited possibilities of the manufacturing of ceramic, takes shape and turns into a complete, efficient, aesthetically satisfying fitting that can strongly define the character of a bathroom. The continuous search for innovation and the ability to constantly evolve according to the different needs of the markets allowed Scarabeo to create a very wide and ever-growing range of washbasins, WC pans and even unique bathroom furniture and accessories of impeccable quality.



DESIGN PLUS



German
Design Award



A'DESIGN AWARD



中国好设计
China Good Design



archiproducts
DESIGN AWARDS

WINNER 2017



FEDERLEGNOARREDO

ARTIGIANALI

A Civita Castellana la lavorazione della ceramica ha origini antichissime, che risalgono all'epoca pre-romana, nell'arco dei secoli le tecniche di lavorazione e i processi produttivi si sono affinati fino a raggiungere l'eccellenza. La ceramica di Scarabeo attraverso la sua produzione si ripropone di recuperare la tecnica dei vari processi lavorativi che tanto sono stati importanti nella tradizione della città. Ogni pezzo viene sottoposto a controlli e attenzioni continue, per correggere qualsiasi imperfezione, garantendo così qualità e bellezza, tanto da avere un apprezzamento crescente sia in ambito nazionale che internazionale.

In Civita Castellana, the ceramic processing industry has ancient origins dating back to the pre-Roman era. Over the course of the centuries, the processing techniques and production processes have evolved to reach high standards of excellence. With its ceramic products, Scarabeo aims to recover the techniques and various processing phases which have been so important for the city's heritage. All items are constantly checked and inspected in order to correct any imperfections and guarantee their quality and beauty; as a result, they are receiving growing appreciation at a national and international level.



DESIGNER

**Giovanna
Talocci**



Interior architect and designer since the 1970s. A natural curiosity for innovation, material research and technology, profound observation of the surrounding reality enabled her to design for prestigious companies, in completely unrelated fields. The same traits are now the pivotal elements in the work of the Talocci Design studio, which specialises in: product design, exhibition design, interior design, event organisation, integrated communication, art direction. Giovanna Talocci has received numerous acknowledgments, among them three ADI Design Index selections, four referrals at the Compasso D'Oro award and four Design Plus prizes. Alongside her design activities, she also works as cultural events curator and consultant for various trade exhibitions, anchor woman and guest of television programmes on design, and lecturer at universities and design schools. She has been a member of ADI (Industrial Design Association) since 1979 and of the ADI National Steering Committee since 2004. In addition, she was a member of the first Italian Council for Design.

Designer, painter and sculptor, he diversified his activities to include the creation of artistic works, setting up of temporary architectural works and installations, and interior furnishing and design. In 2002, he opened his studio - situated in the Viterbo area - and quite naturally made his way into the sanitary ceramics production industry. He designs various collections for companies of the sector and collaborates with Scarabeo on a stable basis.

**Chiara
Valeri**



**Massimiliano
Braconi**



Born in Rome on 21st March 1969, she completed her artistic studies by earning the title of "Master Ceramics Artist" in 1988, after which she began to dedicate herself to artistic ceramics. Subsequently, in 1990, she earned a Diploma in Applied Arts from the "Ulterico Midossi" State Institute of Art in Civita Castellana. In 1990 she graduated from the Rome Fine Arts Academy with a degree in Theatre and Cinema Scenic Design with full marks. She initially embarked on a career in theatre scenic design and subsequently continued her studies in furnishing and design issues. She has created interior design projects for both private customers and retail businesses, while simultaneously collaborating with companies operating in the bathroom furnishing and crockery sectors for outfitting trade fair stands. Since 1997 she has been predominantly focusing on the industrial design sector by collaborating with companies operating in the Civita Castellana industrial scenario.

Lukasz Bertoli _ Graduated in Industrial Design at Politecnico di Milano, Lukasz soon began collaborating with Polidesign and TD studio to develop products for many famous Italian companies such as Chicco and Gardesana. From 2004 to 2008 he was a senior industrial designer at GP designpartners in Vienna where his responsibilities included designing products for brands like Philips, Siemens, Citroen, Doppelmayr, Vienna Acoustics, Tchibo, NXP, Boesendorfer, HEI, Conlastic.

Carlo Ciciliot _ Born in 1982 Carlo graduated in International Relationships at Università degli Studi di Bologna with a Master's in Organization and Economic Development (MOSE) at Profingest Management School. After an important experience at the marketing office of a well established group in the construction sector, he became account manager at Emo design consultancy in 2009.

Davide Vercelli

Giovanni Calisti dedicates himself to art studies and in 1996 gets the qualification of "Maestro d'Arte della Ceramica" (Master of Ceramic Arts). His big passion flew into very appreciated painting and sculpture. He diversifies his activities from creation of artworks to modelling wash basins for a long-established factory in Civita Castellana named ICA. In 1974 he creates SCARABEO, a factory producing exclusively bathroom accessories that makes a name for itself in the European market in few years. In the middle of the nineties he designs different ranges of basins effortlessly. To this day, these ranges are some of the most appreciated of SCARABEO. Always searching for new stimulus, he charts new courses thanks to his clear strategy based on design.



Emo Design

Designer and Engineer Davide Vercelli founded his own firm in 2005 after being a researcher at the Politecnico di Torino. Ever since fond of project culture, of the ways how technological conception and production, communication and marketing strategies interfere in the making and the presentation of a product, he developed through the years a consistent series of co-operation jobs with design companies of different production fields.

A multi-disciplinary and cross-sectoral approach has enabled the studio over the years to support our customers as a global consultant, dealing with product, brand design, brand strategy and exhibit.

From 2013 the studio follows and designs end the main collective event of Cersaie (Aggregati, Cer-Sea, Cer-Style, Cer-Sail, Milleluci, The sound of design), dedicated to contract and wellness.

Numerous are the teaching experiences in co-operation with different institutes and universities such as the Faculty of Design at the Milan Polytechnic University, and I.E.D.. He boasts various international awards: thirteen selections for Adi Design Index, two at Compasso d'Oro, two awards at Young and Design, three Design Plus, one first prize at the International Design Awards, TWO Good Design Award AND ONE IF AND GERMAN DESIGN COUNCIL

Giovanni Calisti

REFERENCES

AUSTRALIA

Grand Mercure Hotel NSW
 Melbourne Convention Center
 Waters Edge Apartments, West End, Brisbane
 Mt.Lawley Apartments, Perth
 New Quay Apartments, Docklands, Melbourne
 Paddington Terraces, Paddington, New South Wales
 CeVue Apartments Scarborough, Western Australia
 Burswood Apartments Tower 5, Burswood, Perth
 ANZ Head Office, Docklands, Melbourne, Victoria
 The Village, Balgowlah, New South Wales
 Nola Road Apartments, Roseville, Sydney, New South Wales
 Westfield Shopping Centre, Plenty Valley, Melbourne, Victoria
 State Circle Apartments, Canberra, Australian Capital Territory

EMIRATES

Elite Residence
 Park Island
 The Lofts
 Princess Tower
 Jumeirah Park

GREECE

Poseidon SA
 Minoa Palace
 Holiday Inn Athens
 66-68 Boundary Street
 Royal Plaza Hotel
 Hung Hom Bay, KIL11120

HONG KONG

Providence Bay

ISRAEL

Crown Plaza - Intercontinental, Tel Aviv
 King's Hotel, Jerusalem
 Carlton Dead Sea, Jerusalem

NEW ZEALAND

Novotel Auckland Airport

SINGAPORE

Visioncrest Residences
 Holland Residences
 Suncottages
 Suites @ Orchard
 831 Upper Serangoon Road
 Waterfront Isle by Far East Development
 Hillsta by Far East Development

KOREA

PoongRim Apartment Incheon
 Pentaport Commercial and Residential Complex
 Queendom Apartments, Busan
 Lafolium Town House Samsung Heavy Industries
 Bill Polaris Villa
 Caelum Villa
 Xii Apartment
 Star Class Villa
 GS Apartment
 The Hill Apartment
 Herrman Haus
 Lotte Hotel Lotte Group
 Lafolium Town House
 PoongDong Apartment
 I-Park Commercial and Residential
 Complex Building
 JW Marriott Seoul



- UNI EN 14688 per lavabi
- UNI EN 997 per WC
- UNI EN 14528 per bidet

Scarabeo ha studiato un sistema che garantisce lo scarico dei suoi WC sospesi, terra e monoblocco con 4,5 litri d'acqua e meno.

The following are the reference standards relative to the CE marking:

- UNI EN 14688 for washbasins
- UNI EN 997 for WCs
- UNI EN 14528 for bidets

Scarabeo studied a new system granting the drainage for its wall hung, floor-standing and monoblock WC with 4.5 litres and even less.

Les normes fonctionnelles de référence pour le marquage CE sont:

- UNI EN 14688 pour les lavabos
- UNI EN 997 pour les WC
- UNI EN 14528 pour les bidets

Scarabeo a étudié un nouveau système qui assure la chasse de ses cuvettes suspendues, à poser ou monobloc avec 4.5 litres d'eau et moins.

Die Bezugsnormen für das CE-Zeichen sind:

- UNI EN 14688 für Waschtische
- UNI EN 997 für WC
- UNI EN 14528 für Bidet

Scarabeo hat für seine Hänge-, Stand- und Kombinations-WCs ein System entwickelt, das nur 4,5 Liter Wasser pro Spülung verbraucht und weniger.

Las normas funcionales de referencia para la marca CE son:

- UNI EN 14688 para lavabos
- UNI EN 997 para inodoros
- UNI EN 14528 para bidé

Scarabeo ha estudiado un sistema que garantiza el desagüe de sus inodoros suspendidos, tierra y mono bloque con 4,5 litros de agua y menos.

Справочные рабочие нормативы для маркировки CE:

- UNI EN 14688 для моек
- UNI EN 997 для унитазов
- UNI EN 14528 для биде

Scarabeo разработала систему, обеспечивающую слив ваших подвесных, напольных и моноблочных унитазов емкостью 4,5 литров воды и меньше.

 -> (1)
SCARABEO CERAMICHE s.r.l. 01034 Fabrica Di Roma - Vt -> (2) 08 -> (3) EN 14688 - CL 25 -> (4)
-> (1)
SCARABEO CERAMICHE s.r.l. 01034 Fabrica Di Roma - Vt -> (2) 07 -> (3) EN 997 - CL 1 - 6 A -> (4)



CERTIFICATIONS

Lavabi a norma di sicurezza, comfort e garanzia delle prestazioni nel tempo. A colonna, sospesi, da incasso o semi incasso, l'offerta dei lavabi e dei sanitari in genere è ormai molto diversificata, sia come tipologia dei materiali utilizzati, sia come forme, stile e design. Ma la Scarabeo da una cosa non può prescindere: dalle prestazioni che questi prodotti devono poter garantire nel tempo. La Scarabeo con l'acquisizione del marchio CE certifica che il prodotto è stato realizzato con materiali testati e con procedure rispondenti agli standard di sicurezza riconosciuti ormai da anni. Il marchio CE è stato istituito per fornire adeguate garanzie del rispetto, da parte del fabbricante, di tutti gli obblighi riguardanti la conformità di un prodotto alle direttive comunitarie e la sua applicazione (obbligatoria) introduce delle prove ferree a cui sottoporre i prodotti.

Conforming washbasins entail: safety, comfort and guaranteed long-lasting performance. Whether column, hunging, built-in or semi built-in, our washbasin offer and sanitary ware offer in general has become highly diversified in terms of variety of materials used, forms, style and design. But there is one aspect that Scarabeo cannot overlook: the performance that these products must ensure over time. By obtaining the CE marking, Scarabeo certifies that the product is manufactured with tested materials and procedures conforming to safety standards that have been widely recognised for several years. The CE marking was introduced to enable manufacturers to adequately guarantee the product's conformity to all the obligations outlined in European Community Directives, and its application (which is mandatory) introduces stringent tests to which products must be subjected.

WC - BIDET

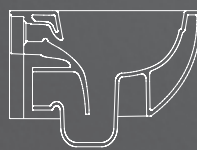

CLEAN FLUSH HUNG WC
Art. 5520/CL - Pag. 16

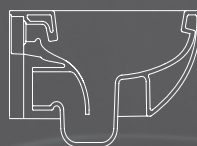

HUNG WC
Art. 5520 - Pag. 16

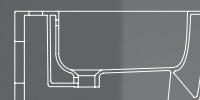

HUNG BIDET
Art. 5521 - Pag. 16

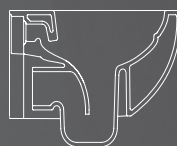

CLEAN FLUSH HUNG WC
Art. 5524/CL - Pag. 17

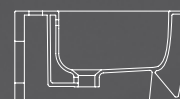

HUNG BIDET
Art. 5525 - Pag. 17



CLEAN FLUSH WC
Art. 5522/CL - Pag. 18

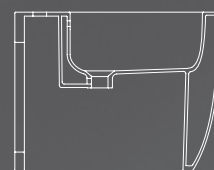

BIDET
Art. 5523 - Pag. 18

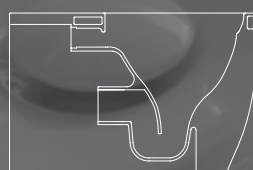

CLEAN FLUSH MONOBLOCK
5526/CL - Pag. 19



CISTERN
Art. 5527 - Pag. 19



42-50 cm

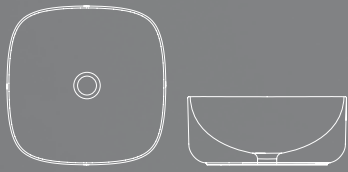

42 H18
Art. 5501 - Pag. 20

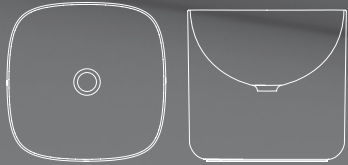

42 H40
Art. 5503 - Pag. 22



42 H85 FLOOR-STANDING
Art. 5510 - Pag. 28

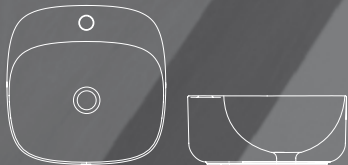

42R H18
Art. 5504 - Pag. 24



42A BUILT-IN
Art. 5511 - Pag. 33

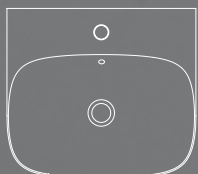

50R H15
Art. 5507 - Pag. 30

70 cm

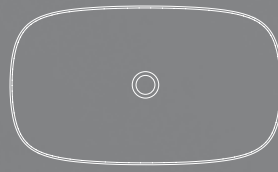

70 H18
Art. 5502 - Pag. 22

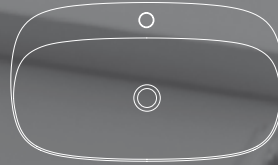

70R H18
Art. 5505 - Pag. 24

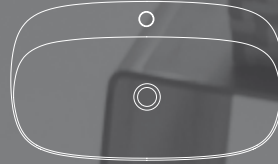

70A BUILT-IN
Art. 5512 - Pag. 33



70R H15
Art. 5508 - Pag. 32

90 cm

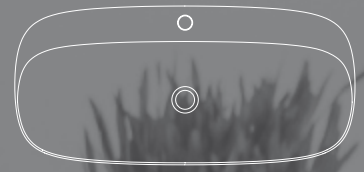

90R H18
Art. 5506 - Pag. 24



90R H15
Art. 5509 - Pag. 32



"Ho ricercato un oggetto semplice, elegante, sinuoso e senza forma ispirandomi a semplici elementi urbani. Ho pensato ad un elemento adattabile al frenetico nostro consumismo ma fisicamente ricercato. Un prodotto dalle forme accoglienti ma generose, in previsione di un nuovo minimalismo umano".

"I envisaged a simple, elegant, sinuous and shapeless object inspired by simple urban elements. The element I conceived is physically sophisticated yet suited to our frenetic consumerism. A product with large, embracing forms that reflects a new human minimalism".

DESIGN
MASSIMILIANO BRACONI

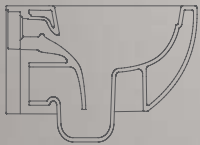

Art. 5520/CL - 50,5 x 36

MOON CLEAN FLUSH HUNG WC

Wc Sospeso - Wall-mounted WC - Cuvette suspendue
Hänge-WC - Inodoro Suspendido - Унитаз подвесной

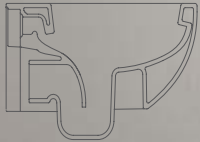

Art. 5520 - 50,5 x 36

HUNG WC

Wc Sospeso - Wall-mounted WC - Cuvette suspendue
Hänge-WC - Inodoro Suspendido - Унитаз подвесной

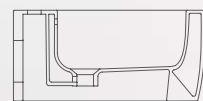

Art. 5521 - 50,5 x 36

MOON HUNG BIDET

Bidet sospeso - Wall-mounted bidet - Bidet suspendu
Hänge-Bidet - Bidet suspendido - Биде подвесное

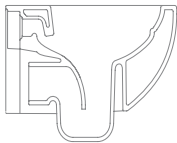

5524/CL - 45 x 35
MOON CLEAN FLUSH HUNG WC
Wc Sospeso - Wall-mounted WC - Cuvette suspendue
Hänge-WC - Inodoro Suspendido - Унитаз подвесной

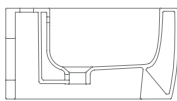

Art. 5525 - 45 x 35
MOON HUNG BIDET
Bidet sospeso - Wall-mounted bidet - Bidet suspendu
Hänge-Bidet - Bidet suspendido - Биде подвесное



Art. 5522/CL - 54,5 x 36 x h42 cm
MOON CLEAN FLUSH WC

Wc a terra, scarico traslato - Floor-mounted wc, shifted outlet
Cuvette au sol, décharge déportée - Bodenstehendes wc, Abfluss versetzt
Inodoro a tierra, desagüe desplazado - Унитаз напольный, Слив передвижной



160 / 170 mm + Art. 10014



60 / 160 mm + Art. 10014/A



170 / 215 mm + Art. 10014/B



345 ± 15 mm + Art. 10028

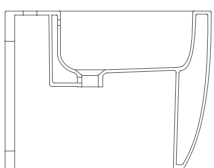

Art. 5523 - 54,5 x 36 x h42 cm
MOON BIDET

Bidet a terra - Floor-mounted bidet - Bidet au sol
Bodenstehendes Bidet - Bidet a tierra - Биде напольное

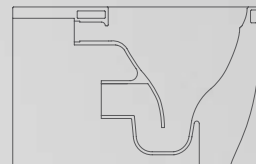

Art. 5526/CL - 66 x 36 x h42 cm

MOON CLEAN FLUSH MONOBLOCK

Wc monoblocco - Monoblock WC - Cuvette monobloc
WC-Kombination - Inodoro monobloque - Моноблочный унитаз



Art. 5527 - 36 x 15 x h44 cm
MOON CISTERN

Cassetta per Art. 5526/CL - Wall cistern for Art. 5526/CL
Réservoir de chasse pour Art. 5526/CL - Spülkasten Für Art. 5526/CL
Cisterna Para Art. 5526/CL - бачок для Art. 5526/CL

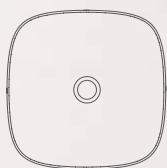

Art. 5501 - 42 x 42 x h18 cm
MOON 42 H18

Lavabo da appoggio - Lay-on washbasin - Lavabo à poser
Aufsatzwaschbecken - Lavabo de apoio - Раковина умывальника накладная



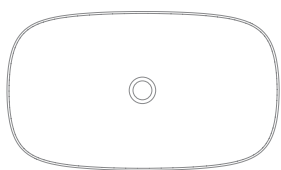

Art. 5502 - 72 x 42 x h18 cm
MOON 70 H18



Art. 5503 - 42 x 42 x h40 cm
MOON 42 H40

Lavabo da appoggio - Lay-on washbasin - Lavabo à poser
Aufsatzwaschbecken - Lavabo de apoio - Раковина умывальника накладная





Art. 5504 - 42 x 42 x h18 cm
MOON 42R H18

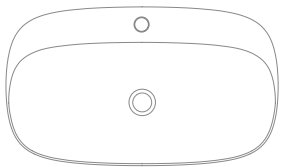

Art. 5505 - 72 x 42 x h18 cm
MOON 70R H18

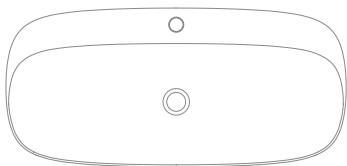

Art. 5506 - 90 x 42 x h18 cm
MOON 90R H18

Lavabo da appoggio - Lay-on washbasin - Lavabo à poser
Aufsatzwaschbecken - Lavabo de apoio - Раковина умывальника накладная









Art. 5531
MOON TOWEL



Art. 5510 - 42 x 42 x h85 cm
MOON 42 H85 FLOOR-STANDING

Lavabo a terra da appoggio - Floor-standing washbasin - Lavabo au sol
Standwaschbecken - Lavabo al suelo de apoyo - Раковина умывальника напольная



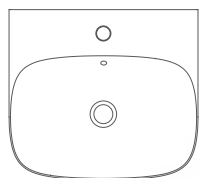

Art. 5507 - 50 x 45 x h15 cm

MOON 50R H15

Lavabo da appoggio o sospeso

Lay-on or wall-mounted washbasin

Lavabo à poser ou suspendu

Aufsatz-oder Hängewaschbecken

Lavabo de apoio o suspendido

Раковина умывальника накладная или подвесная





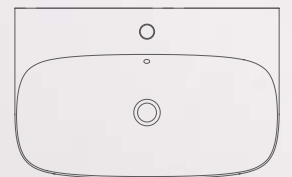

Art. 5508 - 70 x 45 x h15 cm
MOON 70R H15

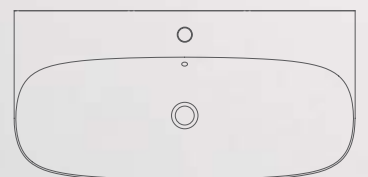

Art. 5509 - 90 x 45 x h15 cm
MOON 90R H15

Lavabo da appoggio o sospeso - Lay-on or wall-mounted washbasin
 Lavabo à poser ou suspendu - Aufsatz- oder Hängewaschbecken
 Lavabo de apoyo o suspendido - Раковина умывальника накладная или подвесная



Art. 5511 - 42 x 42 x h6 cm / total 18 cm
MOON 42A

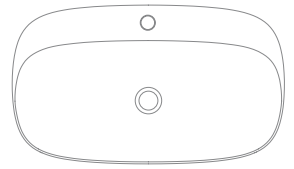

Art. 5512 - 72 x 42 x h6 cm / total 18 cm
MOON 70A

Lavabo da incasso - Built-in washbasin - Lavabo encastré
Einbauwaschbecken - Lavabo de encaje - Раковина умывальника встраиваемая

WC - BIDET



CLEAN FLUSH HUNG WC
Art. 5126/CL - Pag. 37

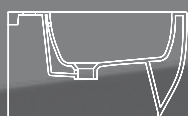

HUNG BIDET
Art. 5127 - Pag. 37

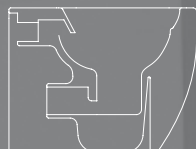

CLEAN FLUSH WC
Art. 5138/CL - Pag. 36



BIDET
Art. 5139 - Pag. 36



CLEAN FLUSH MONOBLOCK
5140/CL - Pag. 38



CISTERN
Art. 5141 - Pag. 38

41-50 cm



TEOREMA 2.0 41R
Art. 5129 - Pag. 44

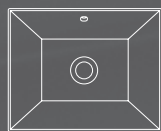

TEOREMA 2.0 45x36
Art. 5130 - Pag. 67

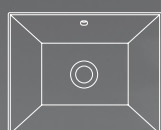

TEOREMA 2.0 45x36S
Art. 5134 - Pag. 70

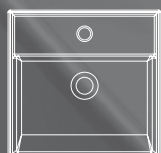

TEOREMA 2.0 45A BUILT-IN
Art. 5108 - Pag. 68

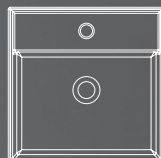

TEOREMA 2.0 46R
Art. 5104 - Pag. 46

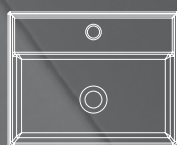

TEOREMA 2.0 50
Art. 5111 - Pag. 43

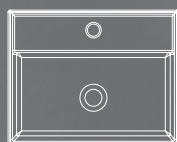

TEOREMA 2.0 50AP
Art. 5112 - Pag. 42

60 cm



TEOREMA 2.0 60
Art. 5101 - Pag. 40

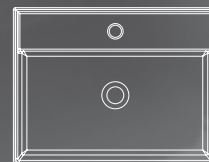

TEOREMA 2.0 60R
Art. 5105 - Pag. 46

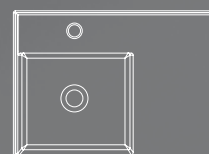

TEOREMA 2.0 60 SHELF DX®
Art. 5114 - Pag. 50

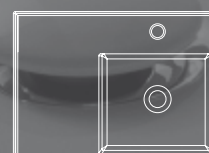

TEOREMA 2.0 60 SHELF SX®
Art. 5117 - Pag. 50

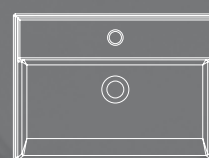

TEOREMA 2.0 60A BUILT-IN
Art. 5109 - Pag. 68

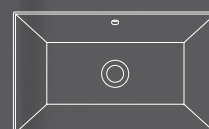

TEOREMA 2.0 60x36
Art. 5131 - Pag. 67

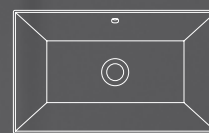

TEOREMA 2.0 60x36S
Art. 5135 - Pag. 70



Nasce TEOREMA 2.0, il lavabo con un'anima sottile dalle dimensioni generose. Un inconsueto e piacevole contrasto tra l'ampiezza del bacino e la leggerezza dei suoi bordi che misurano soltanto pochi millimetri. Un design elegante ed essenziale che coniuga bellezza e praticità. Adatto ad ogni tipologia di abitazione, racchiude in sé quelle caratteristiche funzionali dettate dalle proprie dimensioni che lo rendono un oggetto dalla massima fruibilità anche nelle case dotate di un solo bagno.

The time has come for TEOREMA 2.0, the large-size washbasin with a slim core. The wide bowl offers an appealing and unusual contrast to the light edges, which are only a few millimetres thick. Its elegant, sober design reflects the merging of beauty and practicality. Suitable for any type of home environment, its dimensional characteristics make it a highly practical item that be installed even in homes having a single bathroom.

DESIGN
GIOVANNI CALISTI

TEOREMA 2.0 - ULTRASLIM

80 cm



TEOREMA 2.0 80
Art. 5102 - Pag. 40

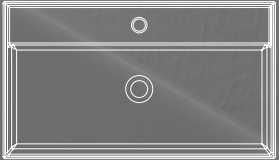

TEOREMA 2.0 80R
Art. 5110 - Pag. 46

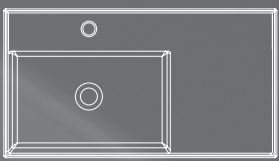

TEOREMA 2.0 80 SHELF DX®
Art. 5115 - Pag. 53

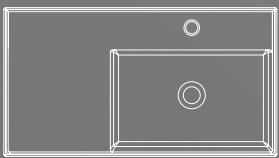

TEOREMA 2.0 80 SHELF SX®
Art. 5118 - Pag. 53

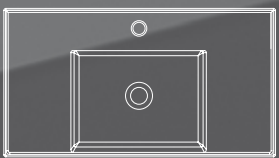

TEOREMA 2.0 80 DOUBLE SHELF®
Art. 5123 - Pag. 60

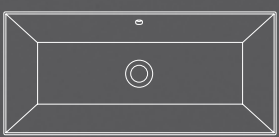

TEOREMA 2.0 80x36
Art. 5132 - Pag. 67

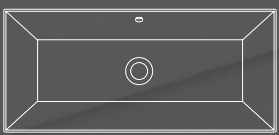

TEOREMA 2.0 80x36S
Art. 5136 - Pag. 70

100 cm

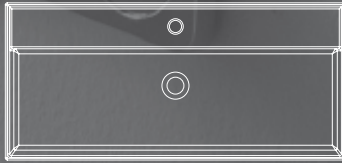

TEOREMA 2.0 100R - A
Art. 5106/R-100/A - Pag. 62

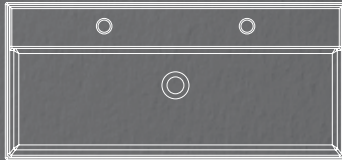

TEOREMA 2.0 100R - B
Art. 5106/R-100/B - Pag. 63

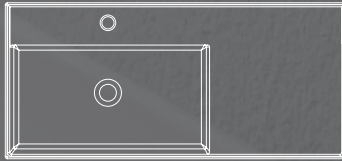

TEOREMA 2.0 100 SHELF DX®
Art. 5119 - Pag. 55

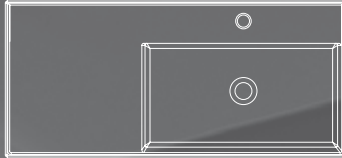

TEOREMA 2.0 100 SHELF SX®
Art. 5120 - Pag. 55

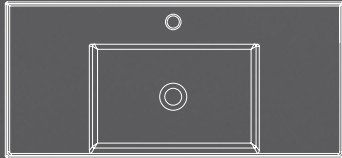

TEOREMA 2.0 100 DOUBLE SHELF®
Art. 5124 - Pag. 60

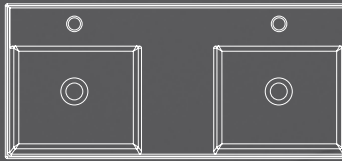

TEOREMA 2.0 101x46
Art. 5142 - Pag. 64

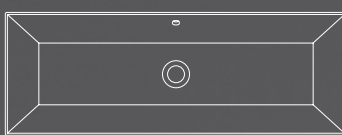

TEOREMA 2.0 100x36
Art. 5133 - Pag. 67

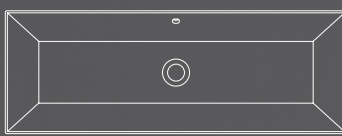

TEOREMA 2.0 100x36S
Art. 5137 - Pag. 70

120-141 cm

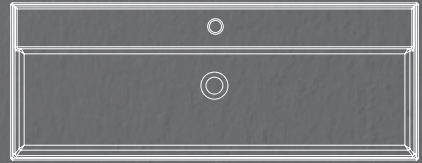

TEOREMA 2.0 120R - A
Art. 5107/R-120/A - Pag. 62

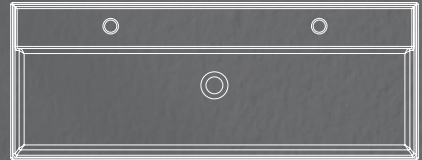

TEOREMA 2.0 120R - B
Art. 5107/R-120/B - Pag. 63

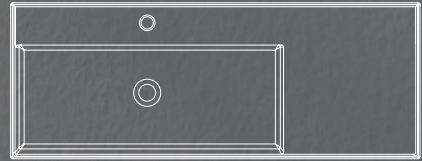

TEOREMA 2.0 120 SHELF DX®
Art. 5121 - Pag. 56

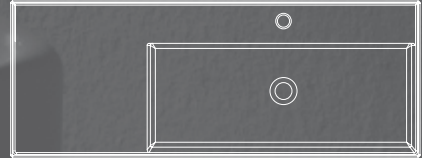

TEOREMA 2.0 120 SHELF SX®
Art. 5122 - Pag. 56

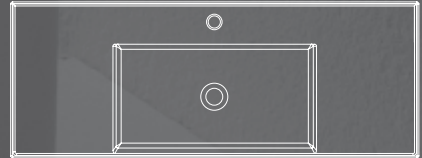

TEOREMA 2.0 120 DOUBLE SHELF®
Art. 5125 - Pag. 60

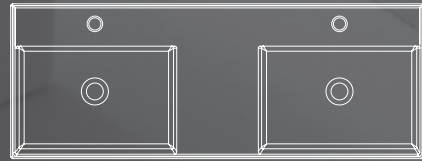

TEOREMA 2.0 121x46
Art. 5143 - Pag. 64

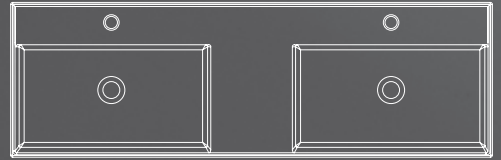

TEOREMA 2.0 141x46
Art. 5116 - Pag. 64

CONSOLE - Pag. 72
TOWEL BAR - Pag. 75

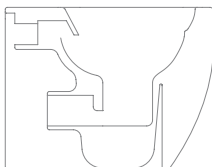

Art. 5138/CL - 55 x 36 x h42 cm
TEOREMA 2.0 CLEAN FLUSH WC

Wc a terra, scarico traslato - Floor-mounted wc, shifted outlet - Cuvette au sol, décharge déportée
Bodenstehendes wc, Abfluss versetzt - Inodoro a tierra, desagüe desplazado - Унитаз напольный,
Слив передвижной



160 / 170 mm + Art. 10014



60 / 160 mm + Art. 10014/A



170 / 215 mm + Art. 10014/B



345 ± 15 mm + Art. 10028

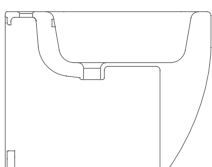

Art. 5139 - 55 x 36 x h42 cm
TEOREMA 2.0 BIDET

Bidet a terra - Floor-mounted bidet - Bidet au sol
Bodenstehendes Bidet - Bidet a tierra - Биде напольное



Art. 5126/CL - 52 x 36 cm
TEOREMA 2.0 CLEAN FLUSH HUNG WC
Wc Sospeso - Wall-mounted WC - Cuvette suspendue
Hänge-WC - Inodoro Suspendido - Унитаз подвесной



Art. 5127 - 52 x 36 cm
TEOREMA 2.0 HUNG BIDET
Bidet sospeso - Wall-mounted bidet - Bidet suspendu
Hänge-Bidet - Bidet suspendido - Биде подвесное

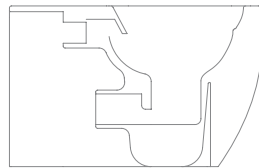

Art. 5140/CL - 66 x 36 x h42 cm
TEOREMA 2.0 CLEAN FLUSH MONOBLOCK
 Wc monoblocco - Monoblock WC - Cuvette monobloc
 WC-Kombination - Inodoro monobloque - Моноблочный унитаз



Art. 5141 - 36 x 15 x h44 cm
TEOREMA 2.0 CISTERN
 Cassetta per Art. 5140/CL - Wall cistern for Art. 5140/CL
 Réservoir de chasse pour Art. 5140/CL - Spülkasten Für Art. 5140/CL
 Cisterna Para Art. 5140/CL - бачок для Art. 5140/CL



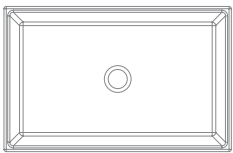

Art. 5101 - 60 x 40 x h14 cm
TEOREMA 2.0 60

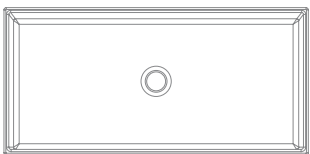

Art. 5102 - 80 x 40 x h14 cm
TEOREMA 2.0 80

Lavabo da appoggio - Lay-on washbasin - Lavabo à poser
Aufsatzwaschbecken - Lavabo de apoio - Раковина умывальника накладная





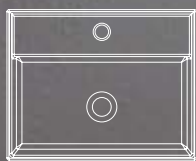

Smaltato su 4 lati
 Enamelled on 4 sides
 Émaillé sur 4 côtés
 Vier Seiten emailliert
 esmaltado por los cuatro lados
 Эмалированный с 4 сторон

Art. 5112 - 50.5 x 38.5 x h14 cm
TEOREMA 2.0 50AP

Lavabo da appoggio, su richiesta tre fori o senza fori rubinetteria

Lay-on washbasin, available with three holes or without holes for tap set

Lavabo à poser, disponible sur demande avec trois trous ou aucun trou de robinetterie

Aufsatzwaschbecken, auf Anfrage drei oder ohne Armaturlöcher

Lavabo de apoyo con predisposición, sobre pedido con tre foros o ningun para grifería

Раковина умывальника накладная. По запросу поставляется с тремя отверстиями под краны или без отверстий

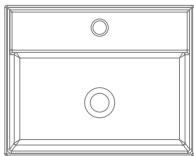

Art. 5111 - 50.5 x 38.5 x h14 cm

TEOREMA 2.0 50

Lavabo da appoggio o sospeso, su richiesta tre fori o senza fori rubinetteria

Lay-on or wall-mounted washbasin, on request, available with three holes or without holes for tap set

Lavabo à poser ou suspendu, disponible sur demande avec trois trous ou aucun trou de robinetterie

Aufsatz-oder Hängewaschbecken, auf Anfrage drei oder ohne Armaturlöcher

Lavabo de apoio o suspendido, sobre pedido con tre foros o ningun para grifería

Раковина умывальника накладная или подвесная. По запросу поставляется с тремя отверстиями под краны или без отверстий

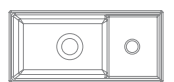

Art. 5129 - 41 x 19 x h10 cm
TEOREMA 2.0 41R

Lavabo da appoggio - Lay-on washbasin - Lavabo à poser
Aufsatzwaschbecken - Lavabo de apoio - Раковина умывальника накладная



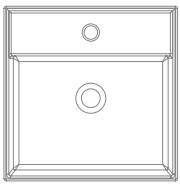

Art. 5104 - 46 x 46 x h14.5 cm
TEOREMA 2.0 46R

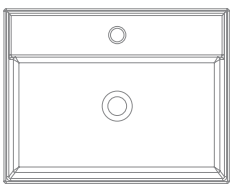

Art. 5105 - 60 x 46 x h14.5 cm
TEOREMA 2.0 60R

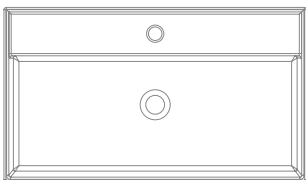

Art. 5110 - 80 x 46 x h14.5 cm
TEOREMA 2.0 80R

Lavabo da appoggio o sospeso, su richiesta tre fori o senza fori rubinetteria
 Lay-on or wall-mounted washbasin, on request, available with three holes or without holes for tap set
 Lavabo à poser ou suspendu, disponible sur demande avec trois trous ou aucun trou de robinetterie
 Aufsatz-oder Hängewaschbecken, auf Anfrage drei oder ohne Armaturlöcher
 Lavabo de apoyo o suspendido, sobre pedido con tre foros o ningun para grifería
 Раковина умывальника накладная или подвесная. По запросу поставляется с тремя отверстиями под краны или без отверстий









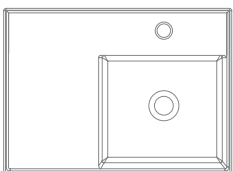

Art. 5117 - 60 x 44 x h14 cm
TEOREMA 2.0 60 SHELF SX®

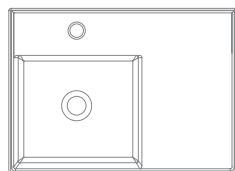

Art. 5114 - 60 x 44 x h14 cm
TEOREMA 2.0 60 SHELF DX®

Lavabo da appoggio o sospeso, su richiesta tre fori o senza fori rubinetteria
 Lay-on or wall-mounted washbasin, on request, available with three holes or without holes for tap set
 Lavabo à poser ou suspendu, disponible sur demande avec trois trous ou aucun trou de robinetterie
 Aufsatz-oder Hängewaschbecken, auf Anfrage drei oder ohne Armaturlöcher
 Lavabo de apoyo o suspendido, sobre pedido con tre foros o ningun para grifería
 Раковина умывальника накладная или подвесная. По запросу поставляется с тремя отверстиями под краны или без отверстий





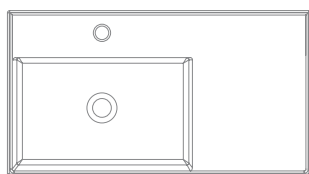

Art. 5115 - 80 x 44 x h14 cm
TEOREMA 2.0 80 SHELF DX®

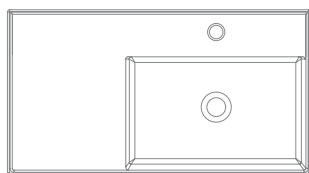

Art. 5118 - 80 x 44 x h14 cm
TEOREMA 2.0 80 SHELF SX®

Lavabo da appoggio o sospeso, su richiesta tre fori o senza fori rubinetteria
Lay-on or wall-mounted washbasin, on request, available with three holes or without holes for tap set
Lavabo à poser ou suspendu, disponible sur demande avec trois trous ou aucun trou de robinetterie
Aufsatz-oder Hängewaschbecken, auf Anfrage drei oder ohne Armaturlöcher
Lavabo de apoyo o suspendido, sobre pedido con tre foros o ningun para grifería
Раковина умывальника накладная или подвесная. По запросу поставляется с тремя отверстиями под краны или без отверстий



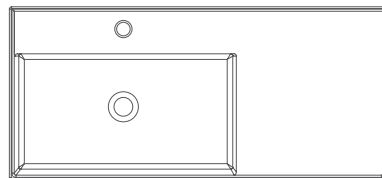

Art. 5119 - 101 x 46 x h14 cm
TEOREMA 2.0 100 SHELF DX®

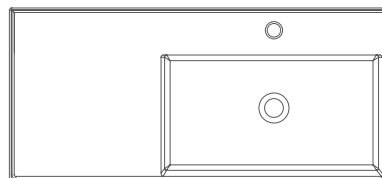

Art. 5120 - 101 x 46 x h14 cm
TEOREMA 2.0 100 SHELF SX®

Lavabo da appoggio o sospeso, su richiesta tre fori o senza fori rubinetteria
Lay-on or wall-mounted washbasin, on request, available with three holes or without holes for tap set
Lavabo à poser ou suspendu, disponible sur demande avec trois trous ou aucun trou de robinetterie
Aufsatz-oder Hängewaschbecken, auf Anfrage drei oder ohne Armaturlöcher
Lavabo de apoyo o suspendido, sobre pedido con tre foros o ningun para grifería
Раковина умывальника накладная или подвесная. По запросу поставляется с тремя отверстиями под краны или без отверстий

- MODELLO REGISTRATO -
- REGISTERED MODEL -



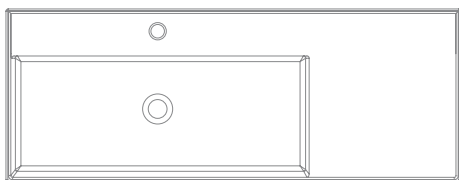

Art. 5121 - 121 x 46 x h14 cm
TEOREMA 2.0 120 SHELF DX®

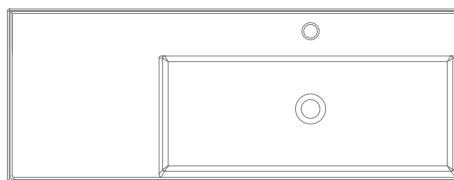

Art. 5122 - 121 x 46 x h14 cm
TEOREMA 2.0 120 SHELF SX®

Lavabo da appoggio o sospeso, su richiesta tre fori o senza fori rubinetteria
 Lay-on or wall-mounted washbasin, on request, available with three holes or without holes for tap set
 Lavabo à poser ou suspendu, disponible sur demande avec trois trous ou aucun trou de robinetterie
 Aufsatz-oder Hängewaschbecken, auf Anfrage drei oder ohne Armaturlöcher
 Lavabo de apoyo o suspendido, sobre pedido con tre foros o ningun para grifería
 Раковина умывальника накладная или подвесная. По запросу поставляется с тремя отверстиями под краны или без отверстий

- MODELLO REGISTRATO -
 - REGISTERED MODEL -







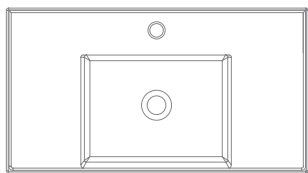

Art. 5123 - 81 x 44 x h14 cm
TEOREMA 2.0 80 DOUBLE SHELF*

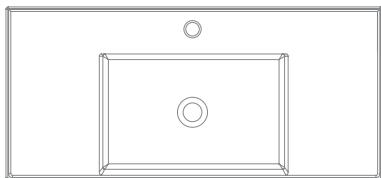

Art. 5124 - 101 x 46 x h14 cm
TEOREMA 2.0 100 DOUBLE SHELF*

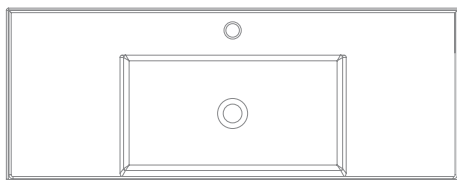

Art. 5125 - 121 x 46 x h14 cm
TEOREMA 2.0 120 DOUBLE SHELF*

Lavabo da appoggio o sospeso, su richiesta tre fori o senza fori rubinetteria
 Lay-on or wall-mounted washbasin, on request, available with three holes or without holes for tap set
 Lavabo à poser ou suspendu, disponible sur demande avec trois trous ou aucun trou de robinetterie
 Aufsatz-oder Hängewaschbecken, auf Anfrage drei oder ohne Armaturlöcher
 Lavabo de apoyo o suspendido, sobre pedido con tre foros o ningun para grifería
 Раковина умывальника накладная или подвесная. По запросу поставляется с тремя отверстиями под краны или без отверстий

- MODELLO REGISTRATO -
 - REGISTERED MODEL -







Art. 5106/R-100A - 100 x 46 x h14.5 cm
TEOREMA 2.0 100R A



Art. 5107/R-120A - 120 x 46 x h14.5 cm
TEOREMA 2.0 120R A

Lavabo da appoggio o sospeso, su richiesta tre fori o senza fori rubinetteria
 Lay-on or wall-mounted washbasin, on request, available with three holes or without holes for tap set
 Lavabo à poser ou suspendu, disponible sur demande avec trois trous ou aucun trou de robinetterie
 Aufsatz- oder Hängewaschbecken, auf Anfrage drei oder ohne Armaturlöcher
 Lavabo de apoio o suspendido, sobre pedido con tre foros o ningun para grifería
 Раковина умывальника накладная или подвесная. По запросу поставляется с тремя отверстиями под краны или без отверстий

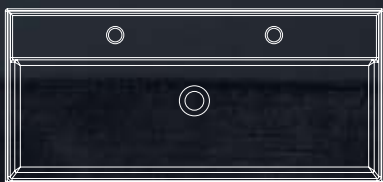
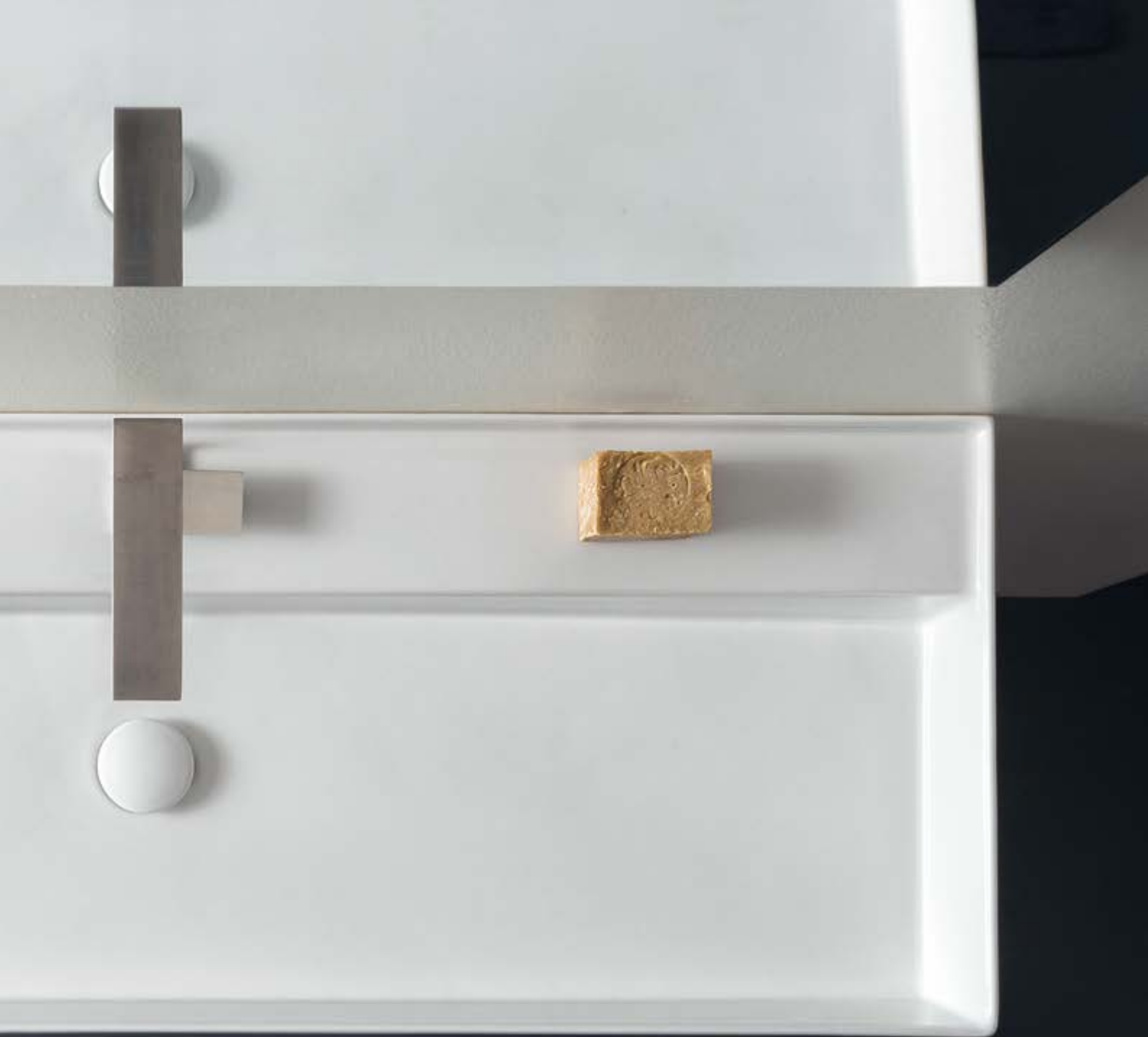

Art. 5106/R-100B - 100 x 46 x h14.5 cm
TEOREMA 2.0 100R B



Art. 5107/R-120B - 120 x 46 x h14.5 cm
TEOREMA 2.0 120R B

Lavabo da appoggio o sospeso - Lay-on or wall-mounted washbasin

Lavabo à poser ou suspendu - Aufsatz-oder Hängewaschbecken

Lavabo de apoyo o suspendido - Раковина умывальника накладная или подвесная

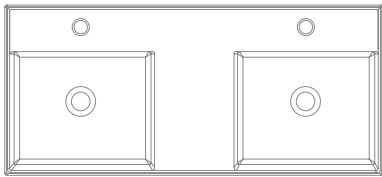

Art. 5142 - 101 x 46 x h14 cm
TEOREMA 2.0 101 x 46

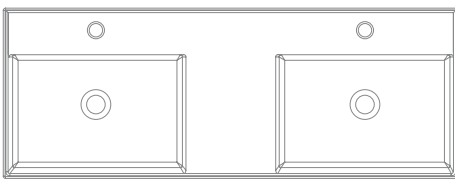

Art. 5143 - 121.5 x 46 x h14 cm
TEOREMA 2.0 121 x 46

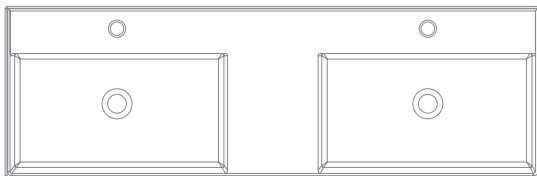

Art. 5116 - 141.5 x 45.5 x h14 cm
TEOREMA 2.0 141 x 46

- MODELLO REGISTRATO -
- REGISTERED MODEL -

Lavabo da appoggio o sospeso, su richiesta tre fori o senza fori rubinetteria
Lay-on or wall-mounted washbasin, on request, available with three holes or without holes for tap set
Lavabo à poser ou suspendu, disponible sur demande avec trois trous ou aucun trou de robinetterie
Aufsatz-oder Hängewaschbecken, auf Anfrage drei oder ohne Armaturlöcher
Lavabo de apoyo o suspendido, sobre pedido con tre foros o ningun para grifería
Раковина умывальника накладная или подвесная. По запросу поставляется с тремя отверстиями под краны или без отверстий





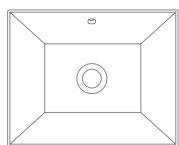

Art. 5130 - 45 x 36 x h5 cm / total 17 cm
TEOREMA 2.0 45x36

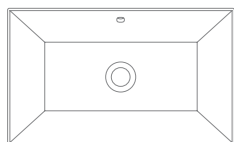

Art. 5131 - 60 x 36 x h5 cm / total 17 cm
TEOREMA 2.0 60x36

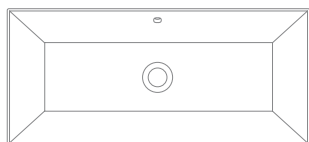

Art. 5132 - 80 x 36 x h5 cm / total 17 cm
TEOREMA 2.0 80x36

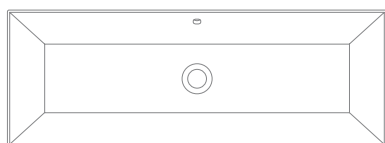

Art. 5133 - 100 x 36 x h5 cm / total 17 cm
TEOREMA 2.0 100x36

Lavabo da incasso - Built-in washbasin - Lavabo encastré
Einbauwaschbecken - Lavabo de encaje - Раковина умывальника встраиваемая

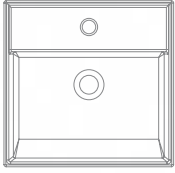

Art. 5108 - 45 x 44 x h7 cm / total 17 cm
TEOREMA 2.0 45A BUILT-IN

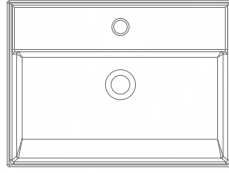

Art. 5109 - 60 x 44 x h7 cm / total 17 cm
TEOREMA 2.0 60A BUILT-IN

Lavabo da incasso, su richiesta tre fori senza fori rubinetteria

Built-in washbasin, on request, available with three holes or without holes for tap set

Lavabo encastré, disponible sur demande avec trois trous ou aucun trou de robinetterie

Einbauwaschbecken, auf Anfrage drei oder ohne Armaturlöcher

Lavabo de encaje, sobre pedido con tre foros o ningun para grifería

Раковина умывальника встраиваемая.

По запросу поставляется с тремя отверстиями

под краны или без отверстий





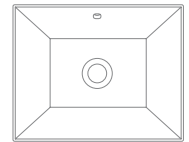

Art. 5134 - 45 x 36 x h0 cm / total 17 cm
TEOREMA 2.0 45x36S

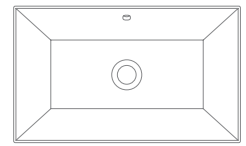

Art. 5135 - 60 x 36 x h0 cm / total 17 cm
TEOREMA 2.0 60x36S

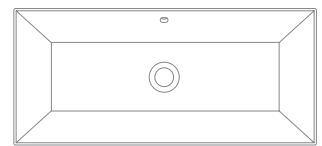

Art. 5136 - 80 x 36 x h0 cm / total 17 cm
TEOREMA 2.0 80x36S

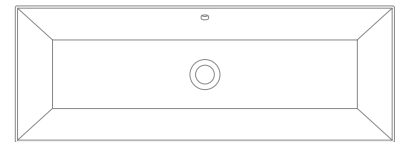

Art. 5137 - 100 x 36 x h0 cm / total 17 cm
TEOREMA 2.0 100x36S

Lavabo sottopiano - Under-top washbasin - Lavabo encastré par dessous
Unterbauwaschbecken - Lavabo bajo encimera - Раковина умывальника под столешницу







Console per lavabo - Console for washbasin - Console pour lavabo
 Konsole für waschbecken - Consolle para lavabo - Подставка под раковину умывальника
 FINISHES: CR - CHROMIUM / NROP - MATT BLACK

Art. 10060 Per - For - Pour - Für - Para - Для: Art.: 5105

Art. 10061 Per - For - Pour - Für - Para - Для: Art.: 5110

Art. 10062 Per - For - Pour - Für - Para - Для: Art.: 5106/R-100/A - /B - Art.: 5119 - Art.: 5120 - Art.: 5124

Art. 10063 Per - For - Pour - Für - Para - Для: Art.: 5107/R-120/A - /B - Art.: 5121 - Art.: 5122 - Art.: 5125

Art. 10064 Per - For - Pour - Für - Para - Для: Art.: 5114 - Art.: 5117

Art. 10065 Per - For - Pour - Für - Para - Для: Art.: 5115 - Art.: 5118 - Art.: 5123







Porta asciugamani - Towel bar - Porte-Serviettes - Handtuchhalter - Toallero - Держатель полотенец
FINISHES: CR - CHROMIUM / NROP - MATT BLACK

Art. 10041 Per - For - Pour - Für - Para - Для: Art.: 5104

Art. 10042 Per - For - Pour - Für - Para - Для: Art.: 5105 - Art.: 5114 - Art.: 5117 - Art.: 5116

Art. 10043 Per - For - Pour - Für - Para - Для: Art.: 5110 - Art.: 5115 - Art.: 5118 - Art.: 5123

Art. 10045 Per - For - Pour - Für - Para - Для: Art.: 5106/R-100/A - /B - Art.: 5119 - Art.: 5120 - Art.: 5124

Art. 10046 Per - For - Pour - Für - Para - Для: Art.: 5107/R-120/A - /B - Art.: 5121 - Art.: 5122 - Art.: 5125



Da mini a maxi in una sola collezione. Questo è il mood che ha ispirato EMO Design nella progettazione di questa nuova serie di lavabi. Dalle linee gentili e raffinate, i lavabi Glam nascono dalla volontà di mostrare il know-how di Scarabeo Ceramiche attraverso la creazione di prodotti in ceramica dai bordi sottilissimi ma con una forte resistenza. Il design pulito e allineato alle tendenze contemporanee del mercato, rende la collezione trasversale ed adattabile a diverse situazioni sia in ambito abitativo che per la comunità o il contract.

From mini to maxi in only one collection. This is the mood that inspired EMO Design for this new washbasin range. With its gentle, refined lines, the Glam collection proves the know-how of Scarabeo Ceramiche through the creation of ceramic products with extremely thin, yet very resistant edges. In line with contemporary market trends, the clean design makes the collection easy to integrate in multiple settings, for residential, community and contract applications.

EMO DESIGN



22-40 cm



GLAM 22
Art. 1809 - Pag. 78



GLAM Ø33
Art. 1808 - Pag. 79



GLAM Ø39
Art. 1807 - Pag. 79



GLAM 40
Art. 1806 - Pag. 80

55-56 cm

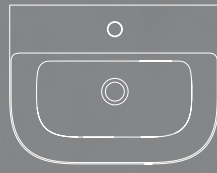

GLAM 55/S
Art. 1811 - Pag. 91



GLAM 56
Art. 1804 - Pag. 83

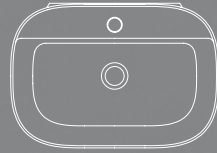

GLAM 56/R
Art. 1802 - Pag. 86

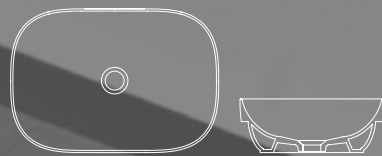

GLAM 56/A BUILT-IN
Art. 1805 - Pag. 92



GLAM 56/AR BUILT-IN
Art. 1810 - Pag. 92

75-95 cm

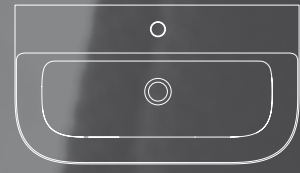

GLAM 75/S
Art. 1812 - Pag. 91



GLAM 76
Art. 1803 - Pag. 83

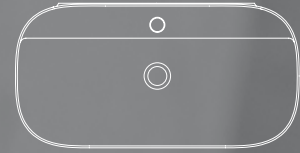

GLAM 76/R
Art. 1801 - Pag. 86

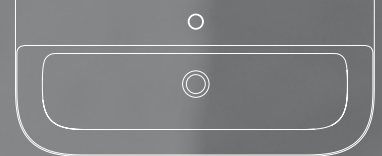

GLAM 95/S
Art. 1813 - Pag. 91



GLAM 95/SB
Art. 1813B - Pag. 91



1809 - 22.5 x 22.5 x h11 cm

GLAM 22

Lavabo da appoggio - Lay-on washbasin - Lavabo à poser

Aufsatzwaschbecken - Lavabo de apoio - Раковина умывальника накладная

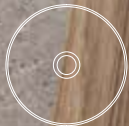

1808 - Ø33 x h12.5 cm
GLAM Ø33

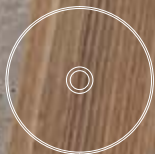

1807 - Ø39 x h14 cm
GLAM Ø39

Lavabo da appoggio - Lay-on washbasin
Lavabo à poser - Aufsatzwaschbecken
Lavabo de apoio - Раковина умывальника накладная



1806 - 40 x 40 x h12.5 cm
GLAM 40

Lavabo da appoggio - Lay-on washbasin - Lavabo à poser
Aufsatzwaschbecken - Lavabo de apoio - Раковина умывальника накладная







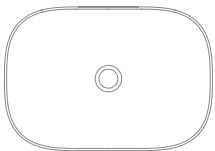

1804 - 56 x 39 x h14 cm
GLAM 56

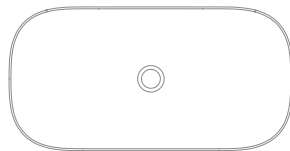

1803 - 76 x 39 x h14 cm
GLAM 76

Lavabo da appoggio - Lay-on washbasin - Lavabo à poser
Aufsatzwaschbecken - Lavabo de apoio - Раковина умывальника накладная





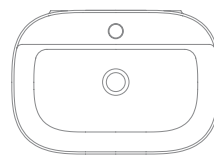

1802 - 56 x 38 x h14 cm
GLAM 56/R

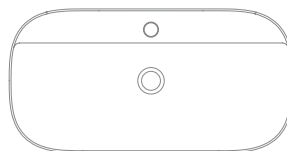

1801 - 76 x 38 x h14 cm
GLAM 76/R

Lavabo da appoggio - Lay-on washbasin - Lavabo à poser
Aufsatzwaschbecken - Lavabo de apoio - Раковина умывальника накладная









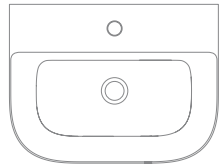

1811 - 55 x 42 x h14 cm
GLAM 55/S

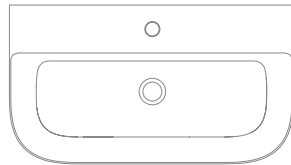

1812 - 75 x 42 x h14 cm
GLAM 75/S

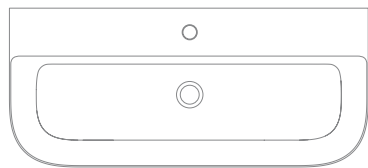

1813 - 95 x 42 x h14 cm
GLAM 95/S

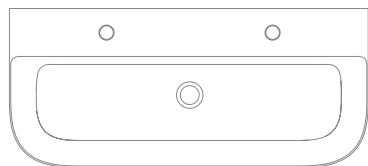

1813B - 95 x 42 x h14 cm
GLAM 95/SB

Lavabo da appoggio o sospeso - Lay-on or wall-mounted washbasin

Lavabo à poser ou suspendu - Aufsatz-oder Hängewaschbecken

Lavabo de apoyo o suspendido - Раковина умывальника накладная или подвесная

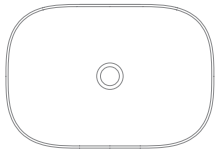

1805 - 56 x 39 x h6 cm / total 14 cm

GLAM 56/A

Lavabo da incasso - Built-in washbasin - Lavabo encastré

Einbauwaschbecken - Lavabo de encaje - Раковина умывальника встраиваемая

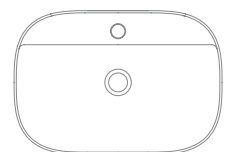

1810 - 56 x 39 x h6 cm / total 14 cm

GLAM 56/AR

Lavabo da incasso - Built-in washbasin - Lavabo encastré

Einbauwaschbecken - Lavabo de encaje - Раковина умывальника встраиваемая





WC - BIDET

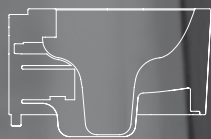

CLEAN FLUSH HUNG WC
Art. 8812/CL - Pag. 96

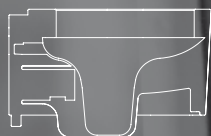

HUNG WC
Art. 8812 - Pag. 96



HUNG BIDET
Art. 8813 - Pag. 96

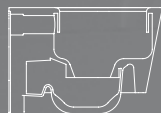

HUNG WC - KIDS
Art. 8815 - Pag. 97

30-35 cm



BUCKET 30
Art. 8801 - Pag. 98



BUCKET 30R
Art. 8802 - Pag. 101



BUCKET 35 h 22
Art. 8808 - Pag. 105



BUCKET 35 h 6
Art. 8811 - Pag. 104

40-50 cm

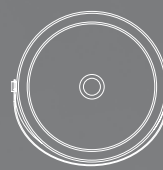

BUCKET 40
Art. 8803 - Pag. 98

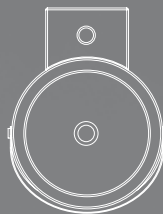

BUCKET 40R
Art. 8804 - Pag. 101

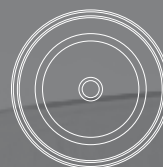

BUCKET 42 h 22
Art. 8807 - Pag. 105



BUCKET 42 h 6
Art. 8810 - Pag. 104

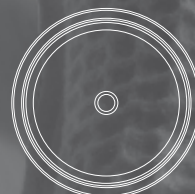

BUCKET 50 h 6
Art. 8809 - Pag. 104

BUCKET DECORATIONS
Pag. 106

BUCKET ACCESORIES
Pag. 114



German
Design Award

DESIGN PLUS

La serie Bucket si distingue per le sue forme che richiamano il tema del secchio/ secchiello, qui declinato in diverse dimensioni e decori. L'oggetto, simbolo del gioco e della semplicità, si trasforma in complemento per il bagno diventando lavabo o lavamano, dove il manico ha la funzione di portasciugamano sia nella versione con attacco a parete sia in quella d'appoggio.

BUCKET line distinguishes itself by its shape bringing to mind just the bucket, in different sizes and decorations. This objet symbolizing the game and the simplicity turns into an essential part of the bathroom becoming wash basin or hand basin where the handle is a towel rail (both for the wall hung and for the supported basins).

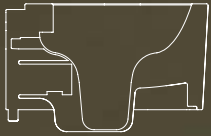

8812/CL - 53,5 x 36
 BUCKET CLEAN FLUSH HUNG WC

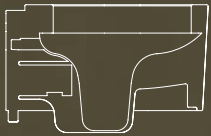

8812 - 53,5 x 36
 BUCKET HUNG WC

Wc Sospeso - Wall-mounted WC
 Cuvette suspendue - Hänge-WC
 Inodoro Suspendido - Унитаз подвесной



Art. 8813 - 53,5 x 36
 BUCKET HUNG BIDET

Bidet sospeso - Wall-mounted bidet - Bidet suspendu
 Hänge-Bidet - Bidet suspendido - Биде подвесное

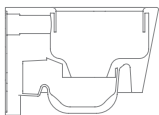

Art. 8815 - 40 x 29

BUCKET HUNG WC - KIDS

Wc Sospeso - Wall-mounted WC - Cuvette suspendue
Hänge-WC - Inodoro Suspendido - Унитаз подвесной



Art. 8801 - Ø30 x h22,5 cm
BUCKET 30

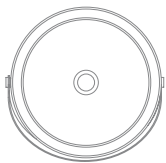

Art. 8803 - Ø40,5 x h35 cm
BUCKET 40

Lavabo da appoggio - Lay-on washbasin - Lavabo à poser
Aufsatzwaschbecken - Lavabo de apoio - Раковина умывальника накладная

- MODELLO REGISTRATO -
- REGISTERED MODEL -







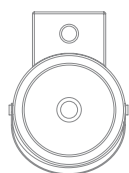

Art. 8802 - 30 x 40 x h22,5 cm
BUCKET 30R

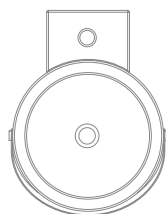

Art. 8804 - 40,5 x 54 x h35 cm
BUCKET 40R

Lavabo da appoggio o sospeso - Lay-on or wall-mounted washbasin
Lavabo à poser ou suspendu - Aufsatz-oder Hängewaschbecken
Lavabo de apoio o suspenso - Раковина умывальника накладная или подвесная

- MODELLO REGISTRATO -
- REGISTERED MODEL -







Art. 8811 - Ø35 x h6 cm
BUCKET 35 h 6

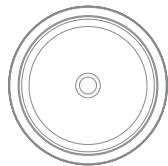

Art. 8810 - Ø42 x h6 cm
BUCKET 42 h 6

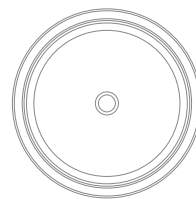

Art. 8809 - Ø50 x h6 cm
BUCKET 50 h 6

Lavabo da appoggio - Lay-on washbasin - Lavabo à poser
Aufsatzwaschbecken - Lavabo de apoio - Раковина умывальника накладная



Art. 8808 - Ø35 x h22 cm
BUCKET 35 h 22



Art. 8807 - Ø42 x h22 cm
BUCKET 42 h 22

Lavabo da appoggio - Lay-on washbasin
Lavabo à poser - Aufsatzwaschbecken
Lavabo de apoio - Раковина умывальника накладная





L'ampia scelta decorativa, dal total white che risalta le forme ai decori geometrici, evocativi o ironici (come il pesciolino che salta dall'acqua), la rende adatta a spazi pubblici: palestre, ristoranti, locali e scuole, ma anche a bagni per la camera dei ragazzi o per chi ama osare con un arredo del bagno piuttosto informale.

Thanks to the wide offer of decorations, beginning from total white bringing out shapes to geometric, evocative or ironic decorations (like the small fish jumping out of water) it is fit for public places like gyms, restaurants, pubs and schools, but even for child bathrooms or for those who love daring with an informal style in their own bathroom.



R
JUMPING FISH



S
DROP



T
PAINT



U
BASKET



V
SWALLOWS



W
LACE



Z
PIXELS



X
SMALL FISHES



Y
ORANGE



K
PORTHOLE



ROM
ROME
NROP
SATIN BLACK - TOWEL RAIL



PAR
PARIS
BS
SATIN WHITE - TOWEL RAIL



BUCKET _ AROUND THE WORLD



MOS
MOSCOW



DXB
DUBAI



SYD
SYDNEY



ROM
ROME



LON
LONDON



TKY
TOKYO



SHA
SHANGHAI



NYC
NEW YORK



PAR
PARIS

BUCKET_KIDS



PSA
FISHING HOOK



RZZ
ROCKET









Art. 8816
Porta sapone da muro
Wall mounted soap dish
Porte-savon mural
Seifenschale für Wandmontage
Porta jabón de pared
Мыльница настенная



Art. 8817
Porta spazzolino da muro
Wall mounted tumbler
Porte-brosses à dent mural
Zahnbürstenbecher für Wandmontage
Porta cepillo de pared
Стакан для зубных щеток настенный



Art. 8818
Porta rotolo da muro
Wall mounted toilet roll holder
Porte-rouleau WC mural
Toilettenpapierhalter für Wandmontage
Porta rollo de pared
Держатель рулона туалетной бумаги настенный



Art. 8822
Portascopino da terra
Freestanding toilet brush
Porte-balayette au sol
Freistehender WC-Bürstenständer
Porta escobilla de suelo
Туалетный ерш напольный



Art. 8821 - L30
 Porta asciugamani
 Towel bar
 Porte-Serviettes
 Handtuchhalter
 Toallero
 Держатель полотенец



Art. 8820 - L60
 Porta asciugamani
 Towel bar
 Porte-Serviettes
 Handtuchhalter
 Toallero
 Держатель полотенец



Art. 8819
 Appendiabiti
 Robe hook
 Porte manteau
 Kleiderhaken
 Perchero
 Вешалка для одежды



Art. 8805 - Ø30
 Porta asciugamani di ricambio Art. 8801 / 8802
 Spare towel rail Art. 8801 / 8802
 Porte-serviettes de rechange Réf. 8801 / 8802
 Ersatz-Handtuchhalter Art. 8801 / 8802
 Portatoallas de repuesto Art. 8801 / 8802
 Запасная вешалка для полотенец Арт. 8801 / 8802



Art. 8806 - Ø40
 Porta asciugamani di ricambio Art. 8803 / 8804
 Spare towel rail Art. 8803 / 8804
 Porte-serviettes de rechange Réf. 8803 / 8804
 Ersatz-Handtuchhalter Art. 8803 / 8804
 Portatoallas de repuesto Art. 8803 / 8804
 Запасная вешалка для полотенец Арт. 8803 / 8804





WC - BIDET

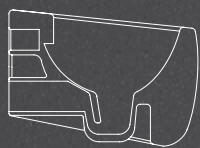

CLEAN FLUSH HUNG WC
Art. 8105/CL - Pag. 120

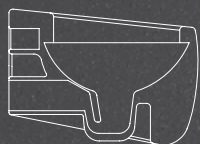

HUNG WC
Art. 8105 - Pag. 120

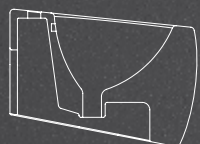

HUNG BIDET
Art. 8106 - Pag. 120

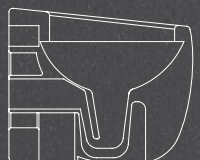

WC
Art. 8401 - Pag. 122

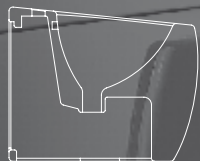

BIDET
Art. 8403 - Pag. 122



CISTERN
Art. 8404 - Pag. 123

45-54 cm



PLANET 48
Art. 8112 - Pag. 127

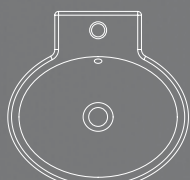

PLANET 48R
Art. 8110 - Pag. 128

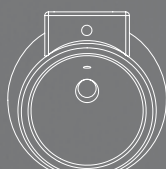

PLANET 42 x 45
Art. 8100 - Pag. 132

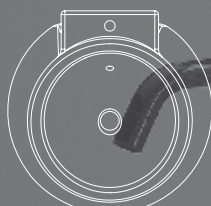

PLANET FLOOR-STANDING
Art. 8104 - Pag. 132

66 - 67 cm

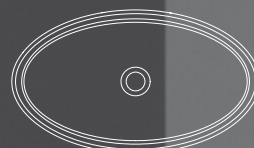

PLANET 66
Art. 8111 - Pag. 127

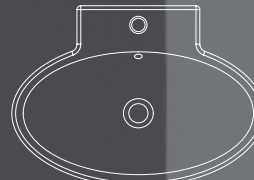

PLANET 67R
Art. 8109 - Pag. 128

La struttura avvolgente, che ricorda vecchi recipienti di tempi passati. Linee sobrie e compatte per un progetto d'arredo completo. E il materiale, la ceramica, lavorata con grande attenzione garantendo un prodotto finale dalle forme estremamente pulite ed ergonomiche.

The enveloping structure calls to mind the old recipients from a bygone age. Simple and compact lines are used for a complete decorative design. The material, ceramic, is processed with great care, guaranteeing an end product which displays extremely clean and ergonomic contours.

DESIGN
MASSIMILIANO BRACONI

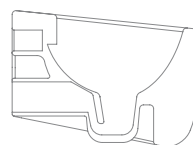

8105/CL - 50 x 45

PLANET CLEAN FLUSH HUNG WC

Wc Sospeso - Wall-mounted WC - Cuvette suspendue
Hänge-WC - Inodoro Suspendido - Унитаз подвесной

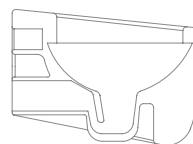

Art. 8105 - 50 x 45

PLANET HUNG WC

Wc Sospeso - Wall-mounted WC - Cuvette suspendue
Hänge-WC - Inodoro Suspendido - Унитаз подвесной

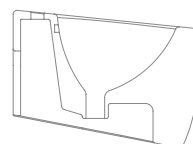

Art. 8106 - 50 x 45

PLANET HUNG BIDET

Bidet sospeso - Wall-mounted bidet - Bidet suspendu
Hänge-Bidet - Bidet suspendido - Биде подвесное





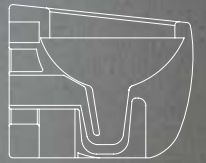

Art. 8401 - 50 x 45 x h44,5 cm
PLANET WC

Wc a terra - Floor-mounted wc
Cuvette au sol - Bodenstehendes wc
Inodoro a tierra - Унитаз напольный



Art. 8403 - 50 x 45 x h44,5 cm
PLANET BIDET

Bidet a terra - Floor-mounted bidet - Bidet au sol
Bodenstehendes Bidet - Bidet a tierra - Биде напольное



Art. 8404 - 38 x 14,5 x h95,5

PLANET CISTERN

Cassetta a muro, comprensiva di batteria a doppio flusso Geberit 6/4,5 lt
Wall cistern, inclusive of flushing system Geberit dual-flush 6/4,5 l
R servoir de chasse mural avec m canisme de chasse   double flux Geberit 6/4,5 L
Wandsp lkasten, einschlielich Batterie mit Geberit-Doppelsp lung 6/4,5 lt
Cisterna de pared, incluido m canismo doble flujo Geberit 6/4,5 lt
Бачок сливной внутривенный с сифоном двухрежимного слива Geberit, 6/4,5л







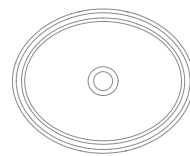

Art. 8112 - 48 x 39 x h16 cm
PLANET 48

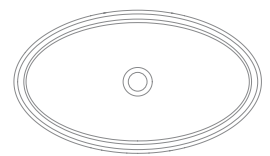

Art. 8111 - 66 x 39 x h16 cm
PLANET 66

Lavabo da appoggio - Lay-on washbasin - Lavabo à poser
Aufsatzwaschbecken - Lavabo de apoio - Раковина умывальника накладная

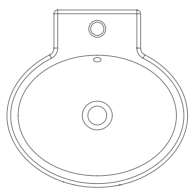

8110 - 48 x 47 x h16 cm
PLANET 48R

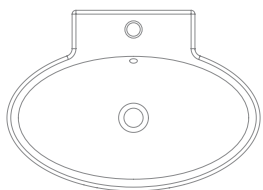

8109 - 67 x 47 x h16 cm
PLANET 67R

Lavabo da appoggio o sospeso - Lay-on or wall-mounted washbasin
Lavabo à poser ou suspendu - Aufsatz-oder Hängewaschbecken
Lavabo de apoio o suspenso - Раковина умывальника накладная или подвесная









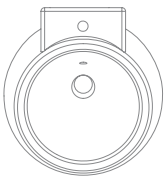

Art. 8100 - 42 x h45 cm

PLANET 42 x 45

Lavabo sospeso - Wall-mounted washbasin - Lavabo suspendu

Hängewaschbecken - Lavabo de encaje - Раковина умывальника подвесная

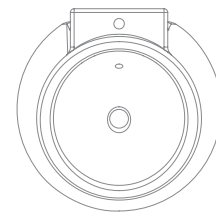

Art. 8104 - Ø54 x h105 cm
PLANET FLOOR-STANDING

Lavabo a terra da appoggio - Floor-standing washbasin - Lavabo au sol
Standwaschbecken - Lavabo al suelo de apoyo - Раковина умывальника напольная





WC - BIDET

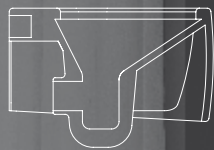

HUNG WC
Art. 8604 - Pag. 136

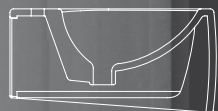

HUNG BIDET
Art. 8605 - Pag. 136

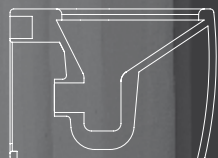

WC
Art. 8606 - Pag. 137



BIDET
Art. 8607 - Pag. 137

51-55 cm



MOAI FLOOR-STANDING
Art. 8603 - Pag. 139

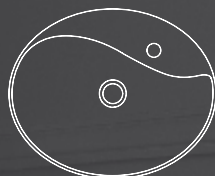

MOAI 55R
Art. 8610 - Pag. 140

71 cm

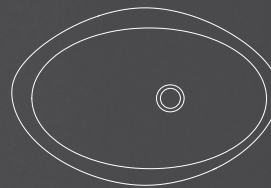

MOAI 71
Art. 8601 - Pag. 143

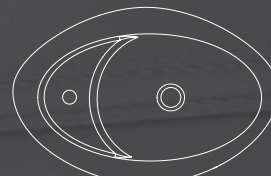

MOAI 71R
Art. 8602 - Pag. 142



Dal mistero dell'isola di Pasqua nasce la linea di lavabi Moai. Simili a monoliti di pietra levigati dalla forza dell'acqua, Moai con le sue linee morbide e sinuose riesce a coniugare l'estetica naturale delle cose e l'innovazione del design contemporaneo.

The Moai range of washbasins takes its inspiration from the mysterious Easter Island. With its soft and shapely lines reminiscent of the stone monoliths polished by the force of the water, Moai successfully combines its natural appearance with an innovative and contemporary design.

DESIGN
MASSIMILIANO BRACONI

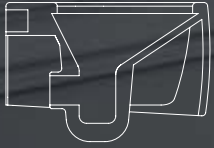

Art. 8604 - 55 x 41

MOAI HUNG WC

Wc Sospeso - Wall-mounted WC - Cuvette suspendue
Hänge-WC - Inodoro Suspendido - Унитаз подвесной

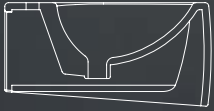

Art. 8605 - 55 x 41

MOAI HUNG BIDET

Bidet sospeso - Wall-mounted bidet - Bidet suspendu
Hänge-Bidet - Bidet suspendido - Биде подвесное





Art. 8606 - 55 x 41 x h41 cm - 6 lt
MOAI WC

Wc a terra - Floor-mounted wc - Cuvette au sol
Bodenstehendes wc - Inodoro a tierra - Унитаз напольный

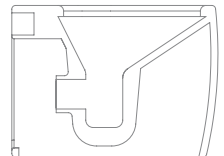

Art. 8607 - 55 x 41 x h41 cm
MOAI BIDET

Bidet a terra - Floor-mounted bidet - Bidet au sol
Bodenstehendes Bidet - Bidet a tierra - Биде напольное

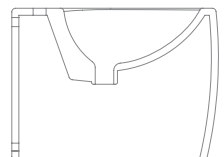

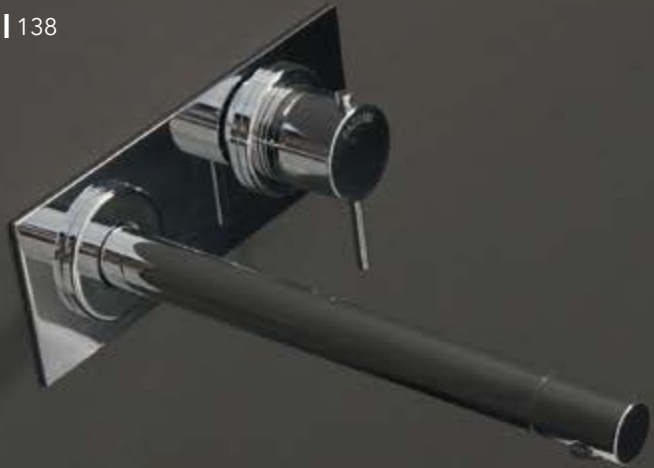

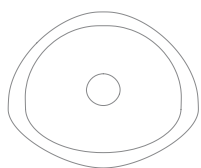

Art. 8603 - 51 x 42,5 x h85 cm

MOAI FLOOR-STANDING

Lavabo a terra da appoggio - Floor-standing washbasin - Lavabo au sol

Standwaschbecken - Lavabo al suelo de apoyo - Раковина умывальника напольная

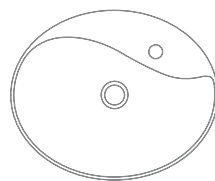

Art. 8610 - 55 x 45 x h15,5 cm
MOAI 55R

Lavabo da appoggio - Lay-on washbasin
Lavabo à poser - Aufsatzwaschbecken
Lavabo de apoio - Раковина умывальника накладная



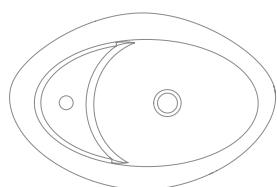

Art. 8602 - 71 x 46 x h18 cm

MOAI 71R

Lavabo da appoggio - Lay-on washbasin

Lavabo à poser - Aufsatzwaschbecken

Lavabo de apoio - Раковина умывальника накладная

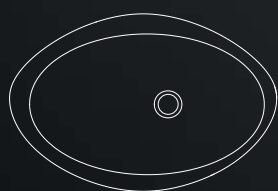

Art. 8601 - 71 x 46 x h18 cm
MOAI 71

Lavabo da appoggio - Lay-on washbasin

Lavabo à poser - Aufsatzwaschbecken

Lavabo de apoio - Раковина умывальника накладная





Sottilissimo e impercettibile, VEIL è il nuovo lavabo di Scarabeo Ceramiche capace di stravolgere la cultura del comune bagno presentandosi come un manufatto raffinato, atipico e limpido, dotato di caparbia personalità. La sua forma nasce da un obiettivo ben definito: la ricerca del vero limite materico. VEIL si presenta infatti come un sottile foglio ceramico sospeso dove lo spessore, così visibilmente ridotto, è il raggiungimento di quello che è il limite ceramico, oltre il quale può esserci solo l'ineseguibile.

Subtle and imperceptible, VEIL is the new wash basin by Scarabeo Ceramiche, it revolutionises the concept of a simple bathroom presenting itself like an refined, atypical and limpid object with its own strong-willed personality. Its shape is the result of a clearly defined objective: seeking the limits of the material from which it is made. VEIL is a thin suspended ceramic sheet where the thickness, visibly limited, is the achievement of the ceramic limit, beyond which there is only the impracticable.

DESIGN
MASSIMILIANO BRACONI



46 cm

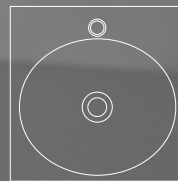

VEIL 46
Art. 6101 - Pag. 147

60 cm

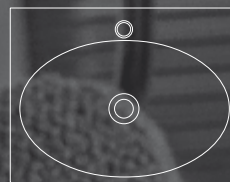

VEIL 60
Art. 6102 - Pag. 149

TOWEL BAR - Pag. 152





6101 - 46 x 46 x h12 cm
VEIL 46

Lavabo sospeso - Wall-mounted washbasin

Lavabo suspendu - Hängewaschbecken

Lavabo suspendido - Раковина умывальника подвесная

- MODELLO REGISTRATO -

- REGISTERED MODEL -



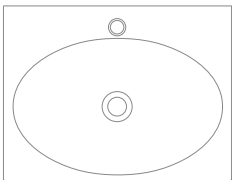

6102 - 60,5 x 46 x h12 cm

VEIL 60

Lavabo sospeso - Wall-mounted washbasin

Lavabo suspendu - Hängewaschbecken

Lavabo suspendido - Раковина умывальника подвесная

- MODELLO REGISTRATO -

- REGISTERED MODEL -





Porta asciugamani - Towel bar - Porte-Serviettes - Handtuchhalter - Toallero - Держатель полотенец

Art. 6103 Per - For - Pour - Für - Para - Для: Art.: 6101

Art. 6104 Per - For - Pour - Für - Para - Для: Art.: 6102





La collezione Fuji di Emo design, composta da lavabo in ceramica, specchio e consolle, è grafica ed essenziale. Il linguaggio progettuale interpreta il continuo fluire dell'acqua attraverso linee convesse che si risolvono in superfici morbide, accarezzando l'utente. La forma armonica e precisa del lavabo è ripresa nei complementi del sistema quali gli specchi e la consolle in tondino di ferro.

Fuji collection of Emo design, composed by ceramic washbasin, mirror and console table, it is graphic and essential. The project design interprets the continuous flowing of water through convex lines becoming soft surfaces, caressing the user. The harmonic and precise shape of the washbasin is taken up again in the complements of the system, such as mirrors and iron rod console table.

EMO DESIGN



German
Design Award



50 cm

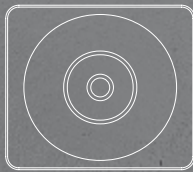

FUJI 50
Art. 6001 - Pag. 156

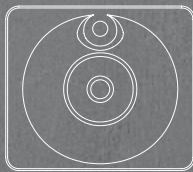

FUJI 50AR
Art. 6013 - Pag. 157

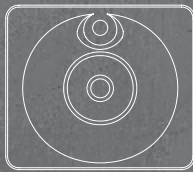

FUJI 50R
Art. 6003 - Pag. 158

70-80 cm

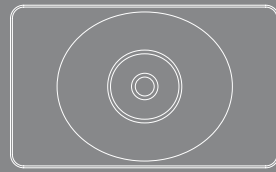

FUJI 70
Art. 6002 - Pag. 160

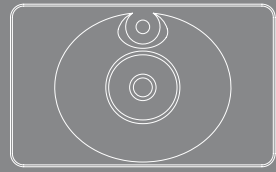

FUJI 70R
Art. 6004 - Pag. 160

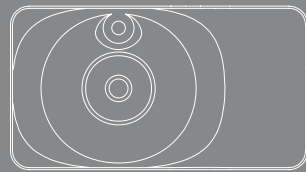

FUJI 80AR SHELF DX
Art. 6014 - Pag. 162

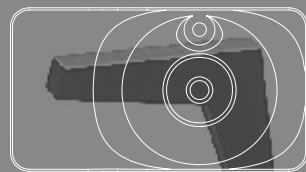

FUJI 80AR SHELF SX
Art. 6015 - Pag. 162

FUJI ACCESSORIES
Pag. 164



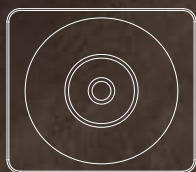

Art. 6001 - 50 x 43.5 x h14 cm
FUJI 50

Lavabo da appoggio o sospeso - Lay-on or wall-mounted washbasin

Lavabo à poser ou suspendu - Aufsatz-oder Hängewaschbecken

Lavabo de apoio o suspenso - Раковина умывальника накладная или подвесная

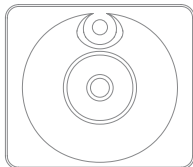

6013 - 50 x 44 x h5 cm / total 17,5 cm

FUJI 50AR

Lavabo da incasso - Built-in washbasin - Lavabo encastré

Einbauwaschbecken - Lavabo de encaje - Раковина умывальника встраиваемая

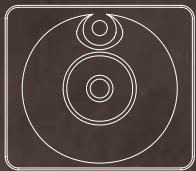

Art. 6003 - 50 x 43.5 x h14 cm
FUJI 50R

Lavabo da appoggio o sospeso
Lay-on or wall-mounted washbasin

Lavabo à poser ou suspendu

Aufsatz-oder Hängewaschbecken

Lavabo de apoyo o suspendido

Раковина умывальника накладная или подвесная





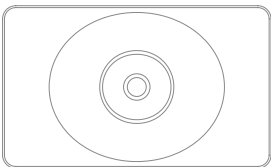

Art. 6002 - 71 x 43 x h14 cm
FUJI 70

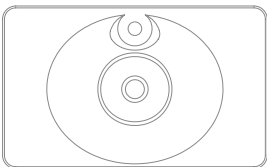

Art. 6004 - 70 x 43 x h14 cm
FUJI 70R

Lavabo da appoggio o sospeso - Lay-on or wall-mounted washbasin
 Lavabo à poser ou suspendu - Aufsatz-oder Hängewaschbecken
 Lavabo de apoyo o suspendido - Раковина умывальника накладная или подвесная



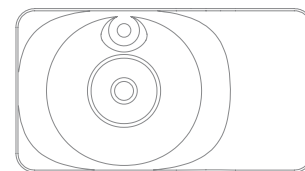

Art. 6014 - 80 x 44 x h5 cm / total 17,5 cm
FUJI 80AR SHELF DX

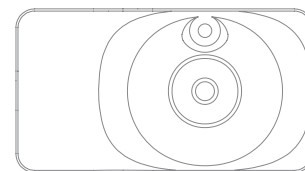

Art. 6015 - 80 x 44 x h5 cm / total 17,5 cm
FUJI 80AR SHELF SX

Lavabo da incasso - Built-in washbasin - Lavabo encastré
Einbauwaschbecken - Lavabo de encaje - Раковина умывальника встраиваемая





Art. 6005 - L59 P44 H75

Consolle per lavabo Fuji Art. 6001 / 6003
 Console for Fuji washbasin Art. 6001 / 6003
 Console pour lavabo Fuji Art. 6001 / 6003
 Konsole für waschbecken Fuji Art. 6001 / 6003
 Consolle para lavabo Fuji Art. 6001 / 6003
 Подставка под раковину умывальника Fuji
 Art. 6001 / 6003



Art. 6006 - L79 P44 H75

Consolle per lavabo Fuji Art. 6002 / 6004
 Console for Fuji washbasin Art. 6002 / 6004
 Console pour lavabo Fuji Art. 6002 / 6004
 Konsole für waschbecken Fuji Art. 6002 / 6004
 Consolle para lavabo Fuji Art. 6002 / 6004
 Подставка под раковину умывальника Fuji
 Art. 6002 / 6004



Art. 6011 - L43 P37 H1

Ripiano in legno per consolle Fuji Art. 6005
 Wooden shelf for Fuji console Art. 6005
 Plan en bois pour console Fuji Art. 6005
 Einlegefach aus holz für konsole Fuji Art. 6005
 Estantería en madera para consolle Fuji Art. 6005
 Деревянная полка для подставки Fuji Art. 6005



Art. 6012 - L63 P37 H1

Ripiano in legno per consolle Fuji Art. 6006
 Wooden shelf for Fuji console Art. 6006
 Plan en bois pour console Fuji Art. 6006
 Einlegefach aus holz für konsole Fuji Art. 6006
 Estantería en madera para consolle Fuji Art. 6006
 Деревянная полка для подставки Fuji Art. 6006







Art. 6009 - Ø50
Specchio tondo Fuji
Fuji round mirror
Miroir rond Fuji
Runder spiegel Fuji
Espejo redondo Fuji
Зеркало круглое Fuji



Art. 6010 - 80 x 70
Specchio rettangolare Fuji
Fuji rectangular mirror
Miroir rectangulaire Fuji
Rechteckiger spiegel Fuji
Espejo rectangular Fuji
Зеркало прямоугольное Fuji



Art. 6007 - L50 x P51
Porta asciugamano Fuji per lavabo Art. 6001 / 6003
Fuji towel rack for washbasin Art. 6001 / 6003
Porte-Serviettes Fuji pour lavabo Art. 6001 / 6003
Handtuchhalter Fuji für waschbecken Art. 6001 / 6003
Toallero Fuji para lavabo Art. 6001 / 6003
Держатель полотенца Fuji для раковины
умывальника Art. 6001 / 6003



Art. 6008 - L70 x P51
Porta asciugamano Fuji per lavabo Art. 6002 / 6004
Fuji towel rack for washbasin Art. 6002 / 6004
Porte-Serviettes Fuji pour lavabo Art. 6002 / 6004
Handtuchhalter Fuji für waschbecken Art. 6002 / 6004
Toallero Fuji para lavabo Art. 6002 / 6004
Держатель полотенца Fuji для раковины
умывальника Art. 6002 / 6004



Mizu, disegnato da Emo design, è un lavabo in ceramica dalla raffinata eleganza. Rappresenta una proposta innovativa che ripensa l'architettura di questo oggetto, qui pensato come un volume composto da più componenti che definiscono la "scocca esterna". In essa il taglio della calotta superiore che disegna la grafica dell'oggetto, svolge la primaria funzione di drenare l'acqua all'interno, dove si trova lo scarico.

Mizu, designed by Emo design, is an elegant ceramic washbasin. It represents an innovative solution that rethinks the object's traditional architecture. Here the washbasin is thought like a volume composed of many components that define the external shell. The central cut of the superior cap, which designs the object's graphic, drains the water in the bowl, where the drain hole is hidden.

EMO DESIGN

DESIGN PLUS

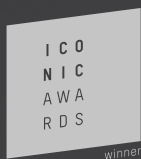

German Design Award



中国好设计
China Good Design

45 cm



MIZU 45 + COVER
Art. 9001 - Pag. 170



MIZU 45
Art. 9005 - Pag. 172



MIZU 45A + COVER BUILT-IN
Art. 9002 - Pag. 175



MIZU 45A BUILT-IN
Art. 9006 - Pag. 175

70 cm



MIZU 70 + COVER
Art. 9003 - Pag. 176



MIZU 70
Art. 9007 - Pag. 176

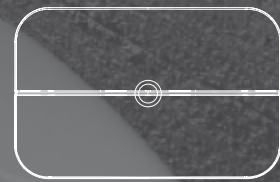

MIZU 70A + COVER BUILT-IN
Art. 9004 - Pag. 179

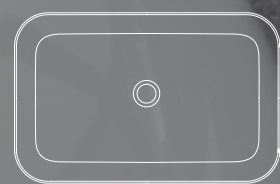

MIZU 70A BUILT-IN
Art. 9008 - Pag. 179



9001 - Ø45 x h15 cm

MIZU 45 + COVER

Lavabo da appoggio - Lay-on washbasin

Lavabo à poser - Aufsatzwaschbecken

Lavabo de apoio - Раковина умывальника накладная

- MODELLO REGISTRATO -

- REGISTERED MODEL -





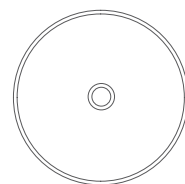

9005 - Ø45 x h14 cm
MIZU 45

Lavabo da appoggio - Lay-on washbasin
Lavabo à poser - Aufsatzwaschbecken
Lavabo de apoio - Раковина умывальника накладная





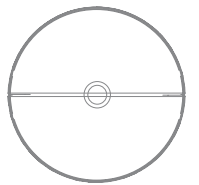

Art. 9002 - Ø45 x h4 cm / total 15 cm
MIZU 45A + COVER

Lavabo da incasso - Built-in washbasin - Lavabo encastré
Einbauwaschbecken - Lavabo de encaje - Раковина умывальника встраиваемая

- MODELLO REGISTRATO -
- REGISTERED MODEL -

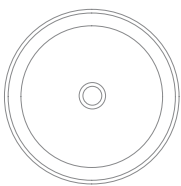

Art. 9006 - Ø45 x h4 cm / total 14 cm
MIZU 45A

Lavabo da incasso - Built-in washbasin - Lavabo encastré
Einbauwaschbecken - Lavabo de encaje - Раковина умывальника встраиваемая



Art. 9007 - 70 x 45 x h14 cm
MIZU 70

- MODELLO REGISTRATO -
- REGISTERED MODEL -

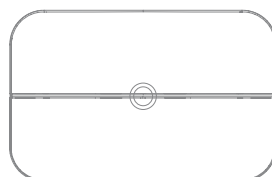

Art. 9003 - 70 x 45 x h15 cm
MIZU 70 + COVER

Lavabo da appoggio - Lay-on washbasin
Lavabo à poser - Aufsatzwaschbecken
Lavabo de apoio - Раковина умывальника накладная









- MODELLO REGISTRATO -
- REGISTERED MODEL -

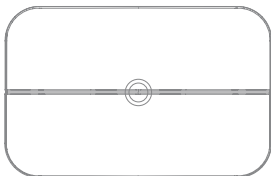

Art. 9004 - 70 x 45 x h4 cm / total 15 cm
MIZU 70A + COVER

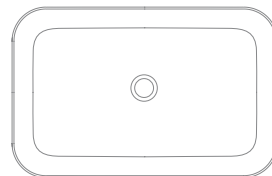

Art. 9008 - 70 x 45 x h4 cm / total 14 cm
MIZU 70A

Lavabo da incasso - Built-in washbasin - Lavabo encastré
Einbauwaschbecken - Lavabo de encaje - Раковина умывальника встраиваемая



SOFT - HUNG - CUBE

SOFT 30-45 cm



SOFT 30
Art. 1503 - Pag. 182

HUNG 40-60 cm

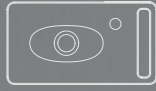

HUNG 40
Art. 1513 - Pag. 186

CUBE 24-42 cm



CUBE 24 H24
Art. 1521 - Pag. 190



SOFT 38
Art. 1502 - Pag. 184

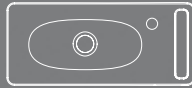

HUNG 50
Art. 1512 - Pag. 189

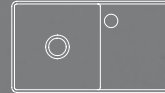

CUBE 42 H24
Art. 1522 - Pag. 192



SOFT 45
Art. 1501 - Pag. 184

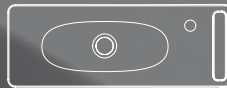

HUNG 60
Art. 1511 - Pag. 189



CUBE 42 H11
Art. 1523 - Pag. 192

SOFT

Rigoroso e pulito, il lavabo Soft mette in evidenza la competenza dell'azienda nella lavorazione della ceramica che qui raggiunge un elevato livello di definizione. Il bordo netto e sottile si pone in netto contrasto con la delicatezza della vasca, caratterizzata da linee morbide che accompagnano l'acqua nel suo fluire.

With its rigorous and clean design, the Soft washbasin highlights the company's ability in use of ceramic, which achieves a high level of definition here. The clean and extremely thin edge stands in sharp contrast with the delicate and smooth lines of the basin which accompany the flow of water.

HUNG

Hung è funzionalità ed ottimizzazione degli spazi. Disegnato da Emo design, questo mini lavabo in ceramica dalla forma rettangolare ospita nella sua struttura principale un foro portasciugamani, mettendo a disposizione tutto il necessario in pochissimo spazio.

Hung is the ideal and functional solution for optimising space. Designed by Emo design, this rectangular mini ceramic washbasin also incorporates a towel rail hole in its main structure, ensuring everything is within easy reach in an extremely small space.

CUBE

Il mini lavabo Cube, disegnato da Emo design, appare come un cubo di ceramica sospeso. Un lavabo dalla forte connotazione estetica che nonostante le dimensioni ridotte non dimentica la funzionalità, presentando una buona profondità della vasca che asseconda il lavaggio delle mani.

The Cube mini washbasin, designed by Emo design, appears like a suspended ceramic cube. The washbasin reveals a distinct aesthetic dimension without renouncing functionality, regardless of its compact dimensions: hand washing is facilitated by the rather large depth of the bowl.



EMO DESIGN



Art. 1503 - 30 x 22 x h10 cm
SOFT 30

Lavabo da appoggio - Lay-on washbasin
Lavabo à poser - Aufsatzwaschbecken

Lavabo de apoio - Раковина умывальника накладная





Art. 1502 - 38 x 22 x h10 cm
SOFT 38



Art. 1501 - 45 x 22 x h10 cm
SOFT 45

Lavabo da appoggio o sospeso - Lay-on or wall-mounted washbasin
 Lavabo à poser ou suspendu - Aufsatz-oder Hängewaschbecken
 Lavabo de apoio o suspenso - Раковина умывальника накладная или подвесная



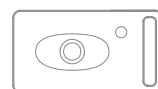

Art. 1513 - 40 x 22 x h9 cm
HUNG 40

Lavabo sospeso - Wall-mounted washbasin
Lavabo suspendu - Hängewaschbecken

Lavabo de encaje - Раковина умывальника подвесная





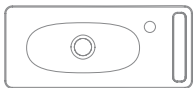

Art. 1512 - 50 x 22 x h9 cm
HUNG 50

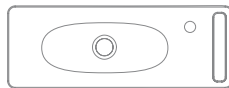

Art. 1511 - 60 x 22 x h9 cm
HUNG 60

Lavabo sospeso - Wall-mounted washbasin
Lavabo suspendu - Hängewaschbecken
Lavabo de encaje - Раковина умывальника подвесная



Art. 1521 - 24 x 24 x h24 cm
CUBE 24 H24

Lavabo da appoggio o sospeso - Lay-on or wall-mounted washbasin

Lavabo à poser ou suspendu - Aufsatz-oder Hängewaschbecken

Lavabo de apoio o suspenso - Раковина умывальника накладная или подвесная



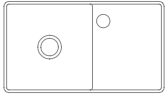

Art. 1522 - 42 x 24 x h24 cm

CUBE 42 H24

Lavabo da appoggio o sospeso - Lay-on or wall-mounted washbasin

Lavabo à poser ou suspendu - Aufsatz-oder Hängewaschbecken

Lavabo de apoio o suspenso - Раковина умывальника накладная или подвесная

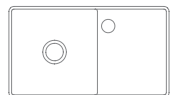

Art. 1523 - 42 x 24 x h11 cm

CUBE 42 H11

Lavabo da appoggio o sospeso - Lay-on or wall-mounted washbasin

Lavabo à poser ou suspendu - Aufsatz-oder Hängewaschbecken

Lavabo de apoio o suspenso - Раковина умывальника накладная или подвесная





39,5-42 cm



SFERA
Art. 8009 - Pag. 196

45-46 cm



CUP
Art. 8044 - Pag. 202

54,5-63 cm

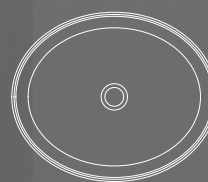

WIND
Art. 8030 - Pag. 208

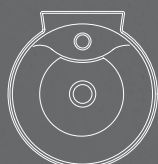

SFERA R
Art. 8009/R - Pag. 197



GEO
Art. 8029 - Pag. 204

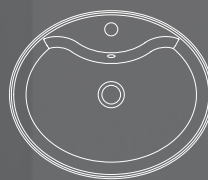

WIND R
Art. 8030/R - Pag. 209

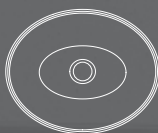

OVO
Art. 8011 - Pag. 198

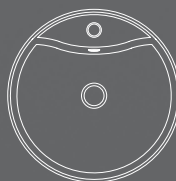

GEO R
Art. 8029/R - Pag. 204



NECK
Art. 8045 - Pag. 210



CONO
Art. 8010 - Pag. 200

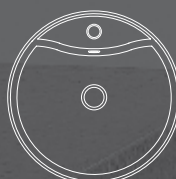

GEO D
Art. 8029/D - Pag. 207

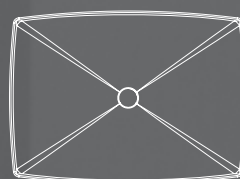

KYLIS
Art. 8046 - Pag. 212



CONO R
Art. 8010/R - Pag. 201

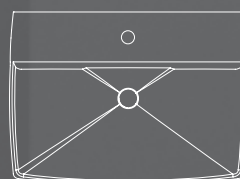

KYLIS R
Art. 8046/R - Pag. 212

Design come espressione di una concezione nuova di vita, più libera. Thin-Line semplice e lineare in tutti i suoi modelli si caratterizza con spessori sottili rinunciando ad inutili orpelli. Rigorosi nella forma e nella funzione, danno vita ad ambienti caldi e moderni, creando un'atmosfera unica anche nei bagni più piccoli.

Design as an expression of a new more liberal concept of life. All Thin-Line models are simple and linear with a slenderness which turns its back on useless embellishments. With its exact lines and function, it breathes life into warm and modern spaces, creating a unique atmosphere even in the smallest of bathrooms.

DESIGN
GIOVANNI CALISTI



Art. 8009 - Ø39,5 x h15 cm
SFERA

Lavabo da appoggio - Lay-on washbasin - Lavabo à poser
Aufsatzwaschbecken - Lavabo de apoio - Раковина умывальника накладная

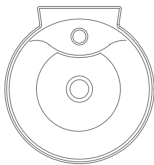

Art. 8009/R - 40 x 42 x h15 cm

SFERA R

Lavabo da appoggio o sospeso - Lay-on or wall-mounted washbasin

Lavabo à poser ou suspendu - Aufsatz-oder Hängewaschbecken

Lavabo de apoio o suspenso - Раковина умывальника накладная или подвесная

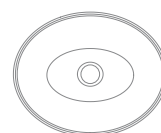

Art. 8011 - 41 x 33,5 x h14 cm
OVO

Lavabo da appoggio - Lay-on washbasin - Lavabo à poser
Aufsatzwaschbecken - Lavabo de apoio - Раковина умывальника накладная



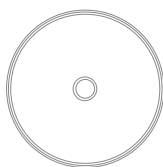

Art. 8010 - Ø42 x h15 cm

CONO

Lavabo da appoggio - Lay-on washbasin - Lavabo à poser

Aufsatzwaschbecken - Lavabo de apoio - Раковина умывальника накладная

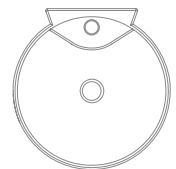

Art. 8010/R - 42 x 43 x h15,5 cm
CONO R

Lavabo da appoggio o sospeso - Lay-on or wall-mounted washbasin

Lavabo à poser ou suspendu - Aufsatz-oder Hängewaschbecken

Lavabo de apoyo o suspendido - Раковина умывальника накладная или подвесная



Art. 8044 - Ø45 x h11 cm

CUP

Lavabo da appoggio - Lay-on washbasin

Lavabo à poser - Aufsatzwaschbecken

Lavabo de aroyo - Раковина умывальника накладная





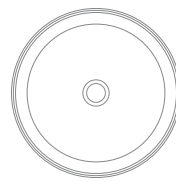

Art. 8029 - Ø45 x h13 cm
GEO

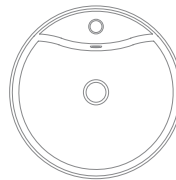

Art. 8029/R - Ø46 x h13 cm
GEO R

Lavabo da appoggio - Lay-on washbasin - Lavabo à poser
Aufsatzwaschbecken - Lavabo de apoio - Раковина умывальника накладная





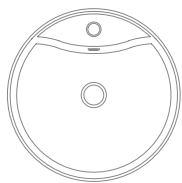

Art. 8029/D - Ø46 x h10 cm / total 13 cm

GEO D

Lavabo da semincasso - Semi built-in washbasin

Lavabo semi encastré - Vorbauwaschbecken

Lavabo de semiencaje - Раковина умывальника полувстраиваемая

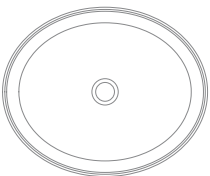

Art. 8030 - 54,5 x 45 x h13 cm

WIND

Lavabo da appoggio - Lay-on washbasin - Lavabo à poser

Aufsatzwaschbecken - Lavabo de apoio - Раковина умывальника накладная

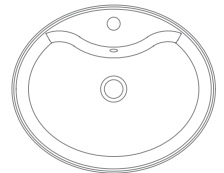

Art. 8030/R - 54,5 x 45 x h13 cm
WIND R

Lavabo da appoggio - Lay-on washbasin - Lavabo à poser
Aufsatzwaschbecken - Lavabo de apoio - Раковина умывальника накладная

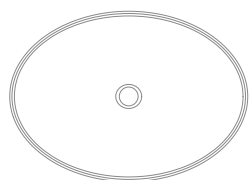

Art. 8045 - 63 x 46 x h15 cm

NECK

Lavabo da appoggio - Lay-on washbasin

Lavabo à poser - Aufsatzwaschbecken

Lavabo de apoio - Раковина умывальника накладная





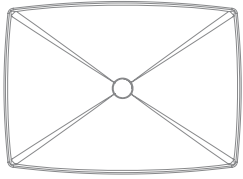

Art. 8046 - 63 x 46 x h12 cm

KYLIS

Lavabo da appoggio - Lay-on washbasin - Lavabo à poser

Aufsatzwaschbecken - Lavabo de apojo - Раковина умывальника накладная

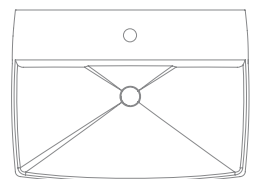

Art. 8046/R - 62 x 44,5 x h14 cm

KYLIS R

Lavabo da appoggio o sospeso - Lay-on or wall-mounted washbasin

Lavabo à poser ou suspendu - Aufsatz-oder Hängewaschbecken

Lavabo de apojo o suspendido - Раковина умывальника накладная или подвесная





60-61,5 cm

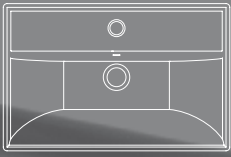

ML 60 x 40
Art. 3001 - Pag. 217

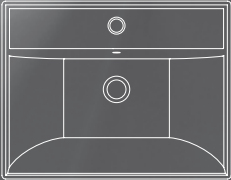

ML 60 x 47
Art. 3004 - Pag. 217

92 cm

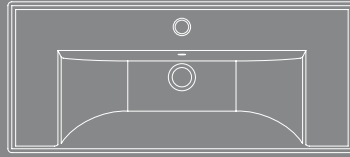

ML 90 x 40
Art. 3002 - Pag. 218

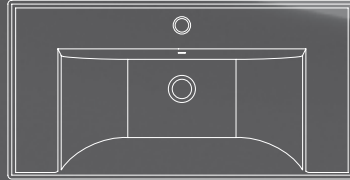

ML 90 x 47
Art. 3005 - Pag. 218

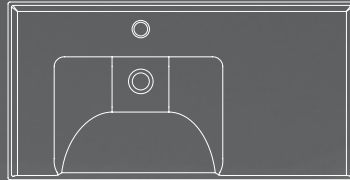

ML 90 x 47 SHELF DX
Art. 3008 - Pag. 218

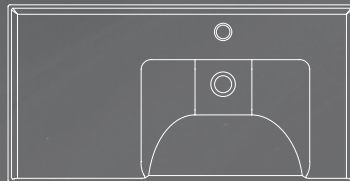

ML 90 x 47 SHELF SX
Art. 3009 - Pag. 218

122 cm

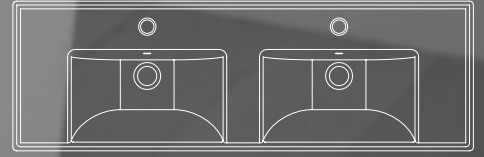

ML 120 x 40
Art. 3003 - Pag. 222

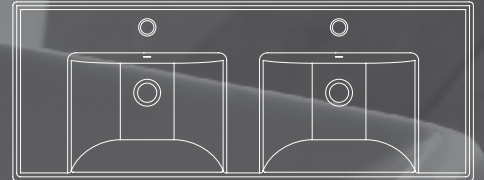

ML 120 x 47
Art. 3006 - Pag. 222

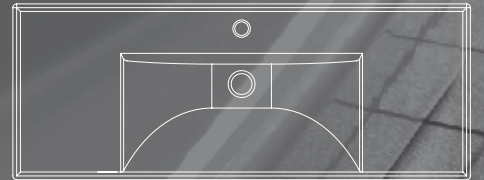

ML 120 x 47 DOUBLE SHELF
Art. 3007 - Pag. 224

TOWEL BAR - Pag. 225

ML dalle forme rigorose attorno alle quali far ruotare una scelta creativa di complementi. ML progetta risposte concrete, qualità e design un privilegio per tutti.

ML with its rigorous forms accompanied by a creative selection of accessories. ML designs tangible solutions - quality and design a privilege for all.

DESIGN
STUDIO TECNICO SCARABEO



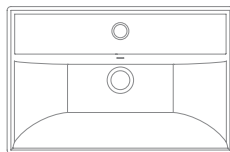

Art. 3001 - 60 x 40 x h5 cm / total 16,5 cm
ML 60 x 40

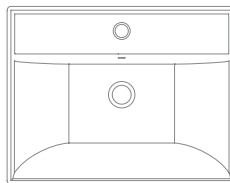

rt. 3004 - 61,5 x 47 x h5 cm / total 16,5 cm
ML 60 x 47

Lavabo da incasso o sospeso - Built-in or wall-mounted washbasin

Lavabo encastré ou suspendu - Einbau-oder Hängewaschbecken

Lavabo de encaje o suspendido - Раковина умывальника встраиваемая или подвесная

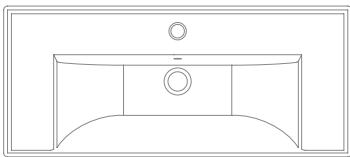

Art. 3002 - 92 x 39 x h5 cm / total 16,5 cm
ML 90 x 40

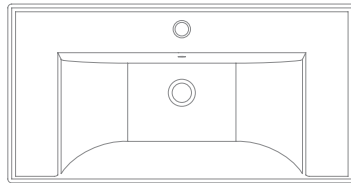

Art. 3005 - 92 x 47 x h5 cm / total 16,5 cm
ML 90 x 47

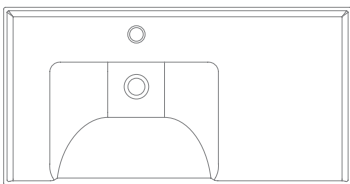

Art. 3008 - 92 x 47 x h5 cm / total 18 cm
ML 90 x 47 SHELF DX

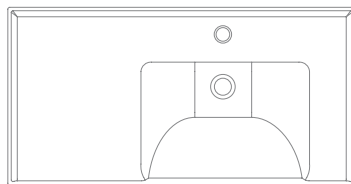

Art. 3009 - 92 x 47 x h5 cm / total 18 cm
ML 90 x 47 SHELF SX

Lavabo da incasso o sospeso - Built-in or wall-mounted washbasin
 Lavabo encastré ou suspendu - Einbau-oder Hängewaschbecken
 Lavabo de encaje o suspendido - Раковина умывальника встраиваемая или подвесная







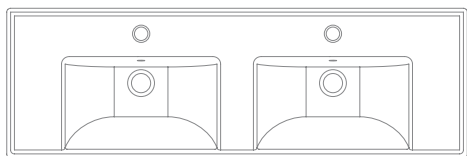

Art. 3003 - 122 x 40 x h5 cm / total 16 cm
ML 120 x 40

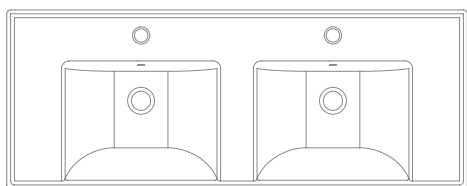

Art. 3006 - 122 x 47 x x h5 cm / total 16 cm
ML 120 x 47

Lavabo da incasso o sospeso - Built-in or wall-mounted washbasin
 Lavabo encastré ou suspendu - Einbau-oder Hängewaschbecken
 Lavabo de encaje o suspendido - Раковина умывальника встраиваемая или подвесная





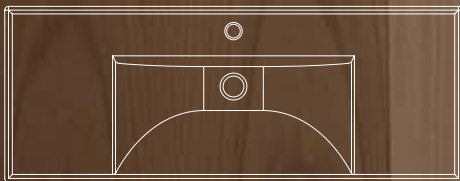

3007 - 121 x 46,5 x h5,5 / total 19 cm

ML 120 x 47 DOUBLE SHELF

Lavabo da incasso o sospeso - Built-in or wall-mounted washbasin

Lavabo encastré ou suspendu - Einbau-oder Hängewaschbecken

Lavabo de encaje o suspendido - Раковина умывальника встраиваемая или подвесная



Porta asciugamani - Towel bar - Porte-Serviettes - Handtuchhalter - Toallero - Держатель полотенец

Art. 10042 Per - For - Pour - Für - Para - Для: Art.: 3001 - 3004

Art. 10044 Per - For - Pour - Für - Para - Для: Art.: 3002 - 3005 - 3008 - 3009

Art. 10046 Per - For - Pour - Für - Para - Для: Art.: 3003 - 3006 - 3007



GAIA 56-87,5 cm

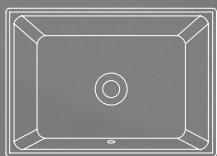

GAIA 50
Art. 8032 - Pag. 228

TECH 54,5 cm

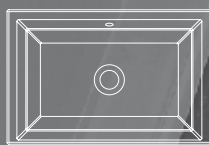

TECH
Art. 8037 - Pag. 230

MIKY 42-87 cm

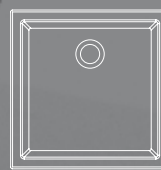

MIKY 35
Art. 8089 - Pag. 232

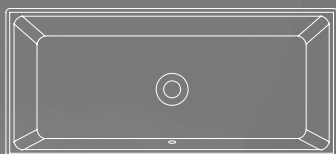

GAIA 80
Art. 8033 - Pag. 228

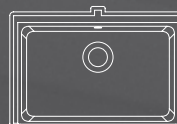

MIKY 40
Art. 8090 - Pag. 232



MIKY 50
Art. 8091 - Pag. 232



MIKY 80
Art. 8092 - Pag. 232

Gaia, Tech e Miky dalla linea semplice e di grande impatto. Grazie alla loro linea sobria e capienza dei loro grandi bacini sono comodi e pratici da usare.

Gaia, Tech and Miky have simple lines and make a great impact. Thanks to their simple shape and the capacity of their large washbasins they are comfortable and practical to use.

DESIGN
STUDIO TECNICO
SCARABEO

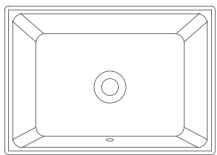

Art. 8032 - 56 x 39,5 x h1,5 cm / total 15,5 cm
GAIA 50

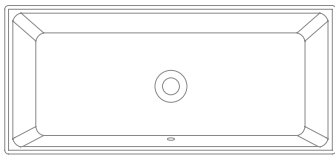

Art. 8033 - 87,5 x 39,5 x h1,5 cm / total 15,5 cm
GAIA 80

Lavabo da incasso - Built-in washbasin - Lavabo encastré
Einbauwaschbecken - Lavabo de encaje - Раковина умывальника встраиваемая



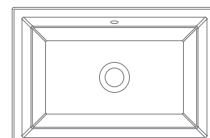

Art. 8037 - 54,5 x 36 x h0 cm / total 16 cm
TECH

Lavabo sottopiano - Under-top washbasin
Lavabo encastré par dessous - Unterbauwaschbecken
Lavabo bajo encimera - Раковина умывальника под столешницу





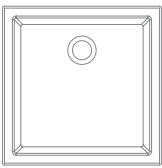

Art. 8089 - 42 x 42 x h0 cm / total 18 cm
MIKY 35

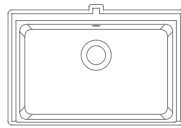

Art. 8090 - 47 x 30,5 x h0 cm / total 20,5 cm
MIKY 40

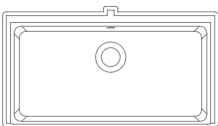

Art. 8091 - 57 x 30,5 x h0 cm / total 20,5 cm
MIKY 50

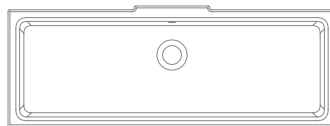

Art. 8092 - 87 x 32 x h0 cm / total 20,5 cm
MIKY 80

Lavabo sottopiano - Under-top washbasin
 Lavabo encastré par dessous - Unterbauwaschbecken
 Lavabo bajo encimera - Раковина умывальника под столешницу



WC - BIDET

30-41 cm



HUNG WC
ART. 8701 - Pag. 237

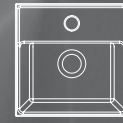

TEOREMA 30R
Art. 8036 - Pag. 240

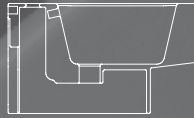

HUNG BIDET
Art. 8702 - Pag. 237

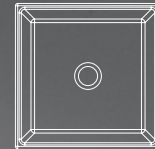

TEOREMA 40
Art. 8031-40 - Pag. 238

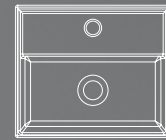

TEOREMA 40X35R
Art. 5001 - Pag. 242

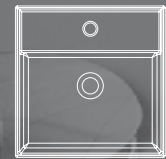

TEOREMA 40R
Art. 8031/R-40 - Pag. 244

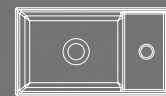

TEOREMA 41x23R
Art. 8031/R-41x23 - Pag. 241

Rigore delle forme, spessori sottilissimi per una linea basic da coniugare all'infinito. Teorema di varie forme e misure per ogni tendenza e per ogni atmosfera del tuo bagno.

Rigorous forms coupled with ultra-thin thickness for a basic range available in endless varieties. A combination of various forms and sizes to accommodate any style and atmosphere for your bathroom.

DESIGN
GIOVANNI CALISTI

46 cm

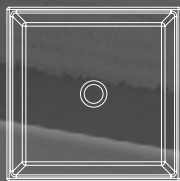

TEOREMA 46
Art. 8031 - Pag. 238

60 -80 cm



TEOREMA 60
Art. 8031-60 - Pag. 238

100-120 cm



TEOREMA 100R - A
Art. 8031/R-100/A - Pag. 248

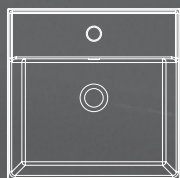

TEOREMA 46R
Art. 8031/R - Pag. 244

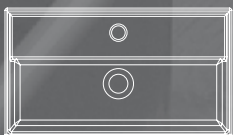

TEOREMA 60X35R
Art. 5002 - Pag. 242



TEOREMA 100R - B
Art. 8031/R-100/B - Pag. 248

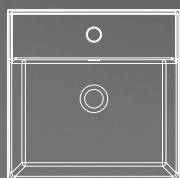

TEOREMA 46D
Art. 8031/D - Pag. 245

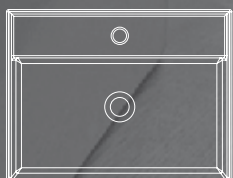

TEOREMA 60R
Art. 8031/R-60 - Pag. 246

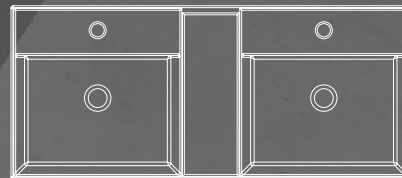

TEOREMA 105R
Art. 8035 - Pag. 250



TEOREMA 80
Art. 8031-80 - Pag. 238

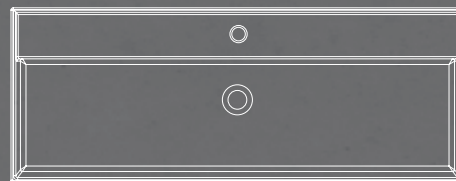

TEOREMA 120R - A
Art. 8031/R-120/A - Pag. 248



TEOREMA 80X35R
Art. 5003 - Pag. 242

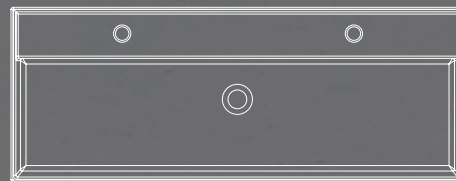

TEOREMA 120R - B
Art. 8031/R-120/B - Pag. 248



TEOREMA 80R
Art. 8031/R-80 - Pag. 246

TOWEL BAR - Pag. 251



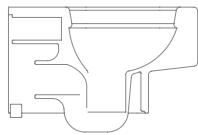

Art. 8701 - 50 x 36 cm

TEOREMA HUNG WC

Wc Sospeso - Wall-mounted WC - Cuvette suspendue
Hänge-WC - Inodoro Suspendido - Унитаз подвесной

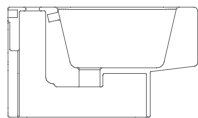

Art. 8702 - 50 x 36 cm

TEOREMA HUNG BIDET

Bidet sospeso - Wall-mounted bidet - Bidet suspendu
Hänge-Bidet - Bidet suspendido - Биде подвесное



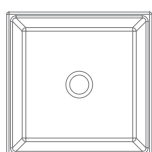

Art. 8031-40 - 39 x 39 x h13 cm
TEOREMA 40

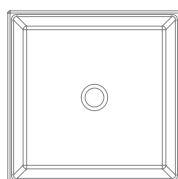

Art. 8031-46 - 46 x 46 x h14 cm
TEOREMA 46

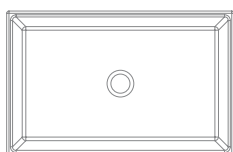

Art. 8031-60 - 60,5 x 38,5 x h13 cm
TEOREMA 60

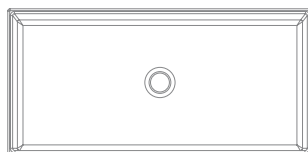

Art. 8031-80 - 80,5 x 39 x h13,5 cm
TEOREMA 80

Lavabo da appoggio - Lay-on washbasin - Lavabo à poser
Aufsatzwaschbecken - Lavabo de apoio - Раковина умывальника накладная



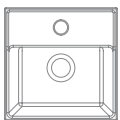

Art. 8036 - 30 x 30 x h11 cm
TEOREMA 30R

Lavabo da appoggio o sospeso - Lay-on or wall-mounted washbasin

Lavabo à poser ou suspendu - Aufsatz-oder Hängewaschbecken

Lavabo de apoio o suspenso - Раковина умывальника накладная или подвесная

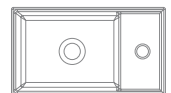

Art. 8031/R-41x23 - 41 x 23 x h14 cm
TEOREMA 41x23R

Lavabo da appoggio o sospeso DX - Lay-on or wall-mounted washbasin RIGHT
Lavabo à poser ou suspendu DROITE - Aufsatz-oder Hängewaschbecken DX
Lavabo de apoyo o suspendido DERECHA - Раковина умывальника накладная или подвесная DX

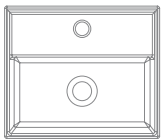

Art. 5001 - 41 x 35 x h14 cm
TEOREMA 40X35R

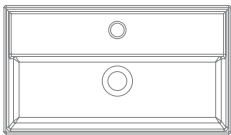

Art. 5002 - 60 x 34 x h14 cm
TEOREMA 60X35R

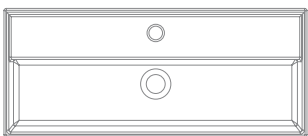

Art. 5003 - 80 x 34 x h14 cm
TEOREMA 80X35R

Lavabo da appoggio o sospeso - Lay-on or wall-mounted washbasin
Lavabo à poser ou suspendu - Aufsatz-oder Hängewaschbecken
Lavabo de apoio o suspenso - Раковина умывальника накладная или подвесная





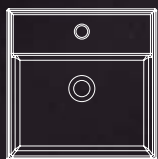

Art. 8031/R-40 - 42 x 41 x h14 cm
TEOREMA 40R

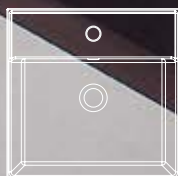

Art. 8031/R - 46 x 46 x h14 cm
TEOREMA 46R

Lavabo da appoggio o sospeso
Lay-on or wall-mounted washbasin
Lavabo à poser ou suspendu
Aufsatz- oder Hängewaschbecken
Lavabo de apoio o suspenso
Раковина умывальника накладная или подвесная

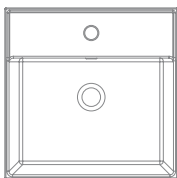

Art. 8031/D - 46 x 46 x h9,5 cm / total 14 cm
TEOREMA 46D

Lavabo da semincasso - Semi built-in washbasin

Lavabo semi incast re - Vorbauwaschbecken

Lavabo de semiencaje - Раковина умывальника полувстраиваемая

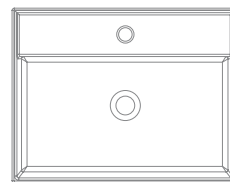

Art. 8031/R-60 - 60 x 46 x h14,5 cm
TEOREMA 60R

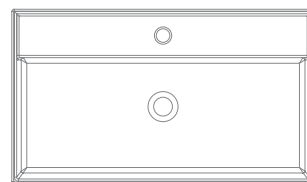

Art. 8031/R-80 - 80 x 46 x h14 cm
TEOREMA 80R

Lavabo da appoggio o sospeso - Lay-on or wall-mounted washbasin
Lavabo à poser ou suspendu - Aufsatz- oder Hängewaschbecken
Lavabo de apoyo o suspendido - Раковина умывальника накладная или подвесная



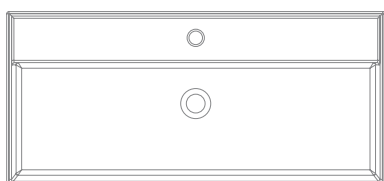

Art. 8031/R-100/A - 100 x 46 x h14 cm
TEOREMA 100R - A

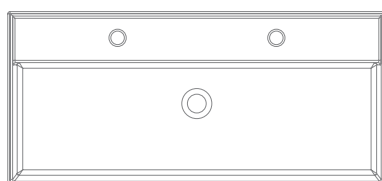

Art. 8031/R-100/B - 100 x 46 x h14 cm
TEOREMA 100R - B

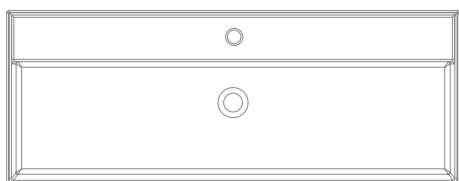

Art. 8031/R-120/A - 120 x 46 x h14,5 cm
TEOREMA 120R - A

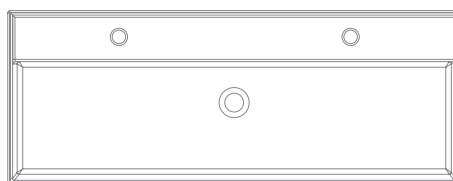

Art. 8031/R-120/B - 120 x 46 x h14,5 cm
TEOREMA 120R - B

Lavabo da appoggio o sospeso - Lay-on or wall-mounted washbasin
 Lavabo à poser ou suspendu - Aufsatz- oder Hängewaschbecken
 Lavabo de apoio o suspenso - Раковина умывальника накладная или подвесная



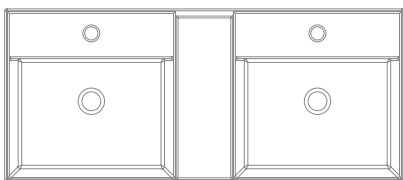

Art. 8035 - 106 x 46 x h14 cm

TEOREMA 105R

Lavabo da appoggio o sospeso - Lay-on or wall-mounted washbasin

Lavabo à poser ou suspendu - Aufsatz-oder Hängewaschbecken

Lavabo de apoio o suspenso - Раковина умывальника накладная или подвесная



Porta asciugamani - Towel bar - Porte-Serviettes - Handtuchhalter - Toallero - Держатель полотенец
FINISHES: CR - CHROMIUM / NROP - MATT BLACK

Art. 10040 Per - For - Pour - Für - Para - Для: Art.: 8031/R41x23 - 8031/R40 - 5001
Art. 10041 Per - For - Pour - Für - Para - Для: Art.: 8031/R
Art. 10042 Per - For - Pour - Für - Para - Для: Art.: 8031/R60 - 5002
Art. 10043 Per - For - Pour - Für - Para - Для: Art.: 8031/R80 - 5003
Art. 10045 Per - For - Pour - Für - Para - Для: Art.: 8031/R-100/A - 8031/R-100/B
Art. 10046 Per - For - Pour - Für - Para - Для: Art.: 8031/R-120/A - 8031/R-120/B



46 cm

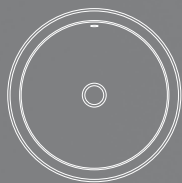

MATTY TONDO
Art. 8055 - Pag. 254

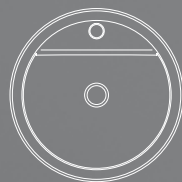

MATTY TONDO R
Art. 8055/R - Pag. 254



MATTY TONDO A BUILT-IN
Art. 8055/A - Pag. 256

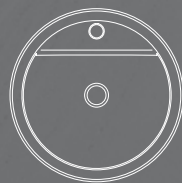

MATTY TONDO A/R BUILT-IN
Art. 8055/A/R - Pag. 257

64 cm

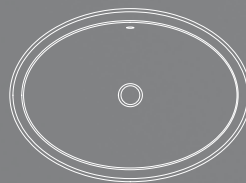

MATTY OVALE
Art. 8056 - Pag. 258

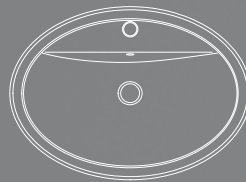

MATTY OVALE R
Art. 8056/R - Pag. 260

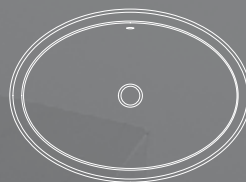

MATTY OVALE A BUILT-IN
Art. 8056/A - Pag. 262

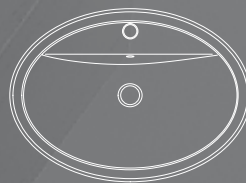

MATTY OVALE A/R BUILT-IN
Art. 8056/A/R - Pag. 263

Matty lo si può guardare da diverse angolazioni ma, a prescindere dal punto di vista, rimane un indiscusso classico. La matita di Giovanni Calisti ha disegnato geometrie morbide e rotonde, che richiamano forme di un tempo.

Matty can be looked at from various angles, but no matter which one it is always an indisputable classic. Giovanni Calisti's pencil has designed soft, rounded lines, which remind us of the forms of days gone by.

DESIGN
GIOVANNI CALISTI

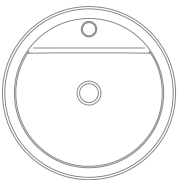

Art. 8055/R - Ø46 x h30 cm
MATTY TONDO R

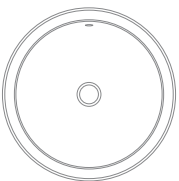

Art. 8055 - Ø46 x h30 cm
MATTY TONDO

Lavabo da appoggio - Lay-on washbasin - Lavabo à poser
Aufsatzwaschbecken - Lavabo de apoio - Раковина умывальника накладная



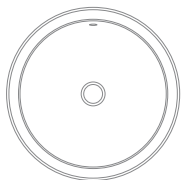

Art. 8055/A - Ø46 x h15 cm / total 30 cm
MATTY TONDO A

Lavabo da incasso - Built-in washbasin - Lavabo encastré

Einbauwaschbecken - Lavabo de encaje - Раковина умывальника встраиваемая

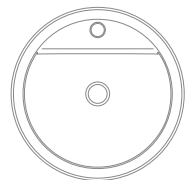

Art. 8055/A/R - Ø46 x h15 cm / total 30 cm
MATTY TONDO /A/R

Lavabo da incasso - Built-in washbasin - Lavabo encastré
Einbauwaschbecken - Lavabo de encaje - Раковина умывальника встраиваемая

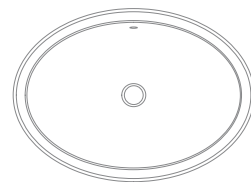

Art. 8056 - 64 x 46 x h30 cm
MATTY OVALE

Lavabo da appoggio - Lay-on washbasin - Lavabo à poser
Aufsatzwaschbecken - Lavabo de apoio - Раковина умывальника накладная



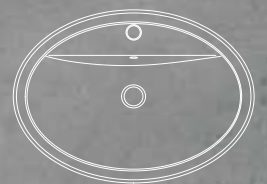

Art. 8056/R - 64 x 46 x h30 cm
MATTY OVALE R

Lavabo da appoggio - Lay-on washbasin - Lavabo à poser
Aufsatzwaschbecken - Lavabo de apoio - Раковина умывальника накладная



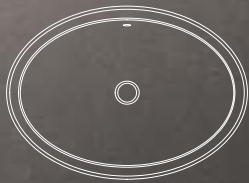

Art. 8056/A - 64 x 46 x h15 cm / total 30 cm
MATTY OVALE A

Lavabo da incasso - Built-in washbasin

Lavabo encastré - Einbauwaschbecken

Lavabo de encaje - Раковина умывальника встраиваемая



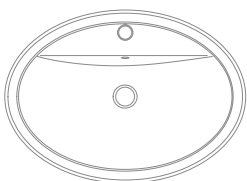

Art. 8056/A/R - 64 x 46 x h15 cm / total 30 cm

MATTY OVALE A/R

Lavabo da incasso - Built-in washbasin - Lavabo encastré

Einbauwaschbecken - Lavabo de encaje - Раковина умывальника встраиваемая



48-72 cm

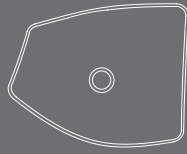

KONG 50
Art. 8051 - Pag. 266

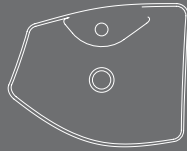

KONG 50R
Art. 8051/R - Pag. 267

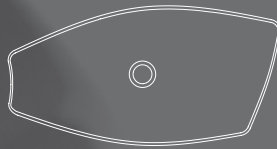

KONG 70
Art. 8052 - Pag. 269

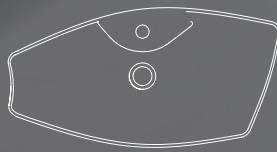

KONG 70R
Art. 8052/R - Pag. 270

90-109 cm

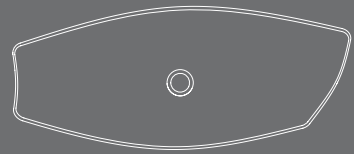

KONG 90
Art. 8053 - Pag. 272

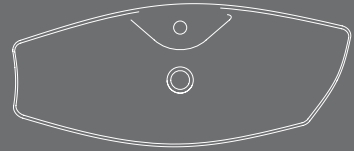

KONG 90R
Art. 8053/R - Pag. 270

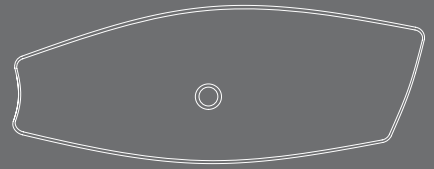

KONG 110
Art. 8054 - Pag. 272

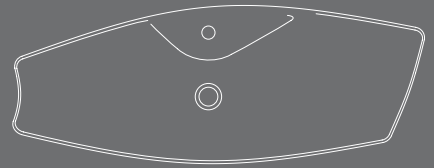

KONG 110R
Art. 8054/R - Pag. 270

Ogni innovazione è l'incontro di un'idea e di un'esigenza e da questo incontro nascono i lavabi Kong, dal disegno moderno, per l'architettura contemporanea. Massimiliano Braconi e Giovanni Calisti hanno creato nuovi spazi per contenere l'acqua, senza nascondere. Un concetto di bagno per chi vive la casa da abitatore.

Innovation is always the result of an idea and a need, and this is how the Kong washbasins were created with their modern design for modern architecture. Massimiliano Braconi and Calisti Giovanni have created new containers for water, without hiding anything. A bathroom concept for those who live in their home.

DESIGN
GIOVANNI CALISTI
MASSIMILIANO BRACONI

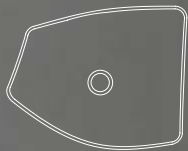

Art. 8051 - 48 x 39 x h15 cm

KONG 50

Lavabo da appoggio - Lay-on washbasin

Lavabo à poser - Aufsatzwaschbecken

Lavabo de apoio - Раковина умывальника накладная



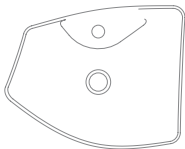

Art. 8051/R - 48 x 39 x h15 cm
KONG 50R

Lavabo da appoggio - Lay-on washbasin - Lavabo à poser
Aufsatzwaschbecken - Lavabo de apoio - Раковина умывальника накладная



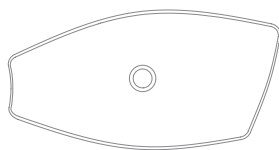

Art. 8052 - 72 x 37 x h13 cm
KONG 70

Lavabo da appoggio - Lay-on washbasin - Lavabo à poser
Aufsatzwaschbecken - Lavabo de apoio - Раковина умывальника накладная

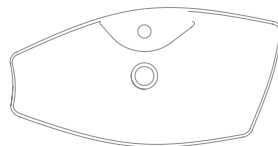

Art. 8052/R - 72 x 37 x h13 cm
KONG 70R

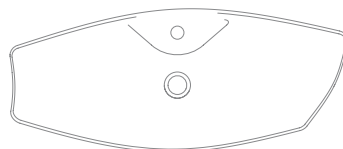

Art. 8053/R - 90 x 38 x h14 cm
KONG 90R

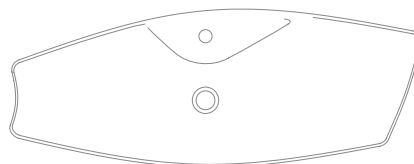

Art. 8054/R - 109 x 42 x h16 cm
KONG 110R

Lavabo da appoggio - Lay-on washbasin - Lavabo à poser
Aufsatzwaschbecken - Lavabo de apoio - Раковина умывальника накладная



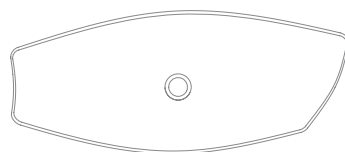

Art. 8053 - 90 x 38 x h14 cm
KONG 90

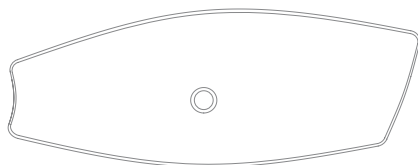

Art. 8054 - 109 x 42 x h16 cm
KONG 110

Lavabo da appoggio - Lay-on washbasin - Lavabo à poser
Aufsatzwaschbecken - Lavabo de apoio - Раковина умывальника накладная





70 cm



TSUNAMI 70
Art. 8039 - Pag. 277

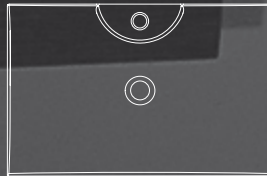

TSUNAMI 70R
Art. 8039/R - Pag. 278

90 cm

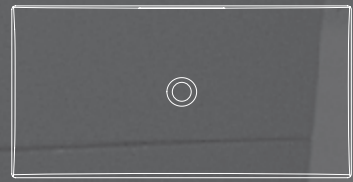

TSUNAMI 90
Art. 8038 - Pag. 277

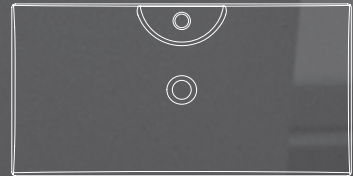

TSUNAMI 90R
Art. 8038/R - Pag. 278

"Tsunami", forse l'unica parola giapponese utilizzata e introdotta in tutte le lingue del mondo, termine che viene dato ad un'onda gigantesca di altezza anomala. Punto di partenza e fonte di ispirazione, ha permesso a Giovanni Calisti e Massimiliano Braconi, di disegnare questo lavabo essenziale: assolutamente necessario; ma anche sobrio nelle forme e senza orpelli inutili coniugando fra loro i termini utilità e semplicità.

Tsunami: possibly the only Japanese word that has been introduced and is utilised in all the world's languages, the term used to define a giant wave of unusual height. This is the starting point and source of inspiration that allowed Giovanni Calisti and Massimiliano Braconi to design this essential washbasin: absolutely necessary, yet with sober shapes and without useless tinsel, a perfect marriage between utility and simplicity.

DESIGN
GIOVANNI CALISTI
MASSIMILIANO BRACONI



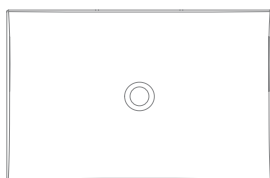

Art. 8039 - 70 x 45,5 x h15,5 cm
TSUNAMI 70

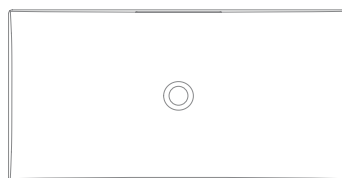

Art. 8038 - 90 x 45,5 x h15,5 cm
TSUNAMI 90

Lavabo da appoggio o sospeso - Lay-on or wall-mounted washbasin

Lavabo à poser ou suspendu - Aufsatz-oder Hängewaschbecken

Lavabo de apoio o suspenso - Раковина умывальника накладная или подвесная

- MODELLO REGISTRATO -

- REGISTERED MODEL -

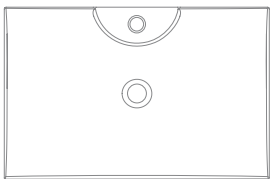

Art. 8039/R - 70 x 45,5 x h15,5 cm
TSUNAMI 70R

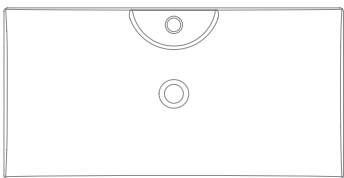

Art. 8038/R - 90 x 45,5 x h15,5 cm
TSUNAMI 90R

Lavabo da appoggio o sospeso - Lay-on or wall-mounted washbasin
Lavabo à poser ou suspendu - Aufsatz-oder Hängewaschbecken
Lavabo de apoio o suspenso - Раковина умывальника накладная или подвесная

- MODELLO REGISTRATO -
- REGISTERED MODEL -







47,5 - 51 cm

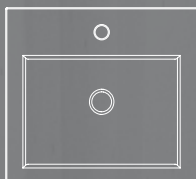

SQUARE 50B
Art. 8025/B - Pag. 282

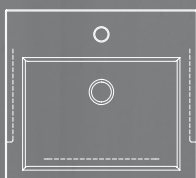

SQUARE 50D
Art. 8025/D - Pag. 285

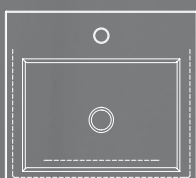

SQUARE 50A
Art. 8025/A - Pag. 287



SQUARE E
Art. 8007/E - Pag. 286

60 cm

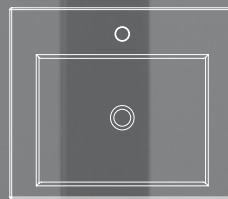

SQUARE 60B
Art. 8007/B - Pag. 282

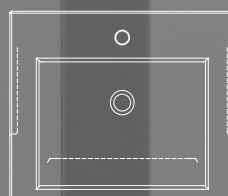

SQUARE 60D
Art. 8007/D - Pag. 285

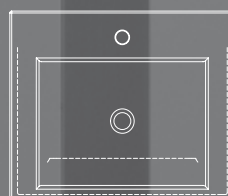

SQUARE 60A
Art. 8007/A - Pag. 287

Dallo studio della SCARABEO nasce la collezione Square di ispirazione inglese reinterpretata per chi vive la casa di oggi. Grazie alla sua linea semplice e sobria ma di grande impatto che li caratterizza, non solo sono esteticamente piacevoli, ma anche ergonomici, dotati di ampi bacini, comodi da usare.

Fresh from the SCARABEO studio comes the Square collection taking its inspiration from England and reinterpreted for those who live in today's home. Thanks to its simple and modest yet highly impressive lines, not only is it attractive but also ergonomic, boasting amply sized washbasins which make for comfortable use.

DESIGN
GIOVANNI CALISTI

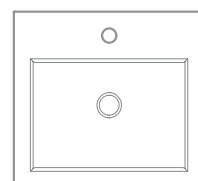

Art. 8025/B - 51 x 46 x h16 cm
SQUARE 50B

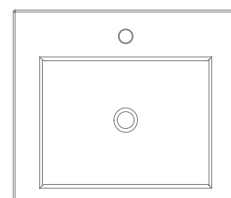

Art. 8007/B - 60 x 51 x h16 cm
SQUARE 60B

Lavabo da appoggio o sospeso - Lay-on or wall-mounted washbasin
Lavabo à poser ou suspendu - Aufsatz-oder Hängewaschbecken
Lavabo de apoyo o suspendido - Раковина умывальника накладная или подвесная





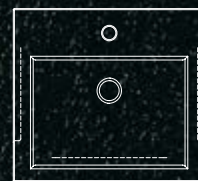

Art. 8025/D - 51 x 46 x h8,5 cm / total 16 cm
SQUARE 50D

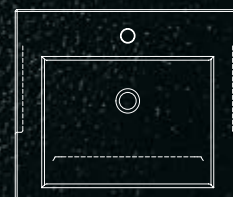

Art. 8007/D - 60 x h8,5 cm / total 16 cm
SQUARE 60D

Lavabo da semincasso - Semi built-in washbasin
Lavabo semi encastré - Vorbauwaschbecken
Lavabo de semiensaje - Раковина умывальника полувстраиваемая



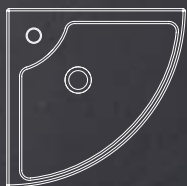

Art. 8007/E - 47,5 x 47,5 x h14 cm
SQUARE E

Lavabo da appoggio o sospeso - Lay-on or wall-mounted washbasin

Lavabo à poser ou suspendu - Aufsatz-oder Hängewaschbecken

Lavabo de apoio o suspenso - Раковина умывальника накладная или подвесная

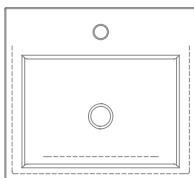

Art. 8025/A - 51 x 46 x h8,5 cm / total 16 cm
SQUARE 50A

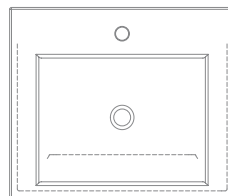

Art. 8007/A - 61 x 51 x h8,5 cm / total 16 cm
SQUARE 60A

Lavabo da incasso - Built-in washbasin - Lavabo encastré
Einbauwaschbecken - Lavabo de encaje - Раковина умывальника встраиваемая



Arco è un lavabo ad incasso che si presta a molte configurazioni ed utilizzi, declinato in due misure, 60 o 80 cm. Le linee leggermente arcuate, da cui il nome del prodotto, il pianetto interno ribassato e il bordo estremamente sottile conferiscono al lavabo eleganza e leggerezza e lo rendono adatto ad ambientazioni sia classiche che di design. Il bacino ampio e profondo risponde alle nuove tendenze di arredo del bagno e permette di utilizzarlo non solo come lavabo d'arredo ma anche come vaschetta per lavare qualche capo di biancheria. Il profilo del lavabo, caratterizzato da un bordo leggermente bombato, sottolinea il disegno del prodotto e permette di incassare una parte della profondità restituendo leggerezza.

Arco is a recessed washbasin which has many configurations and uses, available in two sizes, 60 or 80 cm. The slightly arched lines, from which the product gets its name, the lowered inner surface and the extremely slender edge make the washbasin elegant and light, and also suitable for both classic and design surroundings. The wide and deep basin reflect current design trends for bathrooms and allow it to be used not only as a washbasin but also as a tub for washing clothes. The profile of the washbasin, with its slightly convex edge, emphasises the design of the product and allows it to be partially recessed, giving a lighter appearance.

DESIGN
GIOVANNA TALOCCI

60 cm

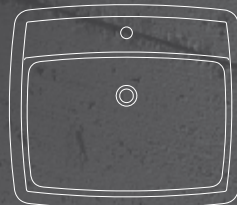

ARCO 60
Art. 1001 - Pag. 290

80 cm

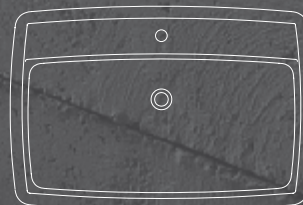

ARCO 80
Art. 1002 - Pag. 292



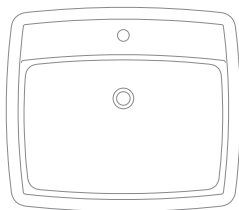

Art. 1001 - 60 x 46,5 x h13 cm / total 30 cm
ARCO 60

Lavabo da incasso - Built-in washbasin - Lavabo encastré

Einbauwaschbecken - Lavabo de encaje - Раковина умывальника встраиваемая

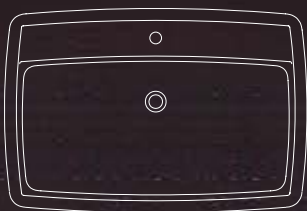

Art. 1002 - 80 x 46,5 x h13 cm / total 30 cm

ARCO 80

Lavabo da incasso - Built-in washbasin

Lavabo encastré - Einbauwaschbecken

Lavabo de encaje - Раковина умывальника встраиваемая







Etra dal carattere essenziale accoglie con semplicità l'acqua, elemento di vita e indiscussa protagonista di benessere. Etra disegnata con mestria fonde audaci geometrie per dar vita a uno stile contemporaneo e dallo spirito easy-chic.

Etra welcomes water - the element of life and the undisputed protagonist of wellness - with simplicity and a minimalist approach. Thanks to its skillful design it blends bold geometries, giving life to a contemporary style with an easy-chic spirit.

DESIGN
STUDIO TECNICO
SCARABEO



61 cm

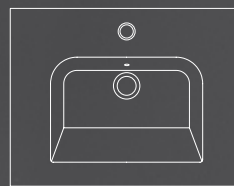

ETRA 61x47
Art. 5210 - Pag. 296

82 cm

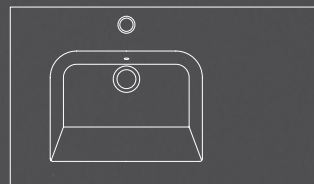

ETRA 82x47
Art. 5211 - Pag. 297

CONSOLE - Pag. 300

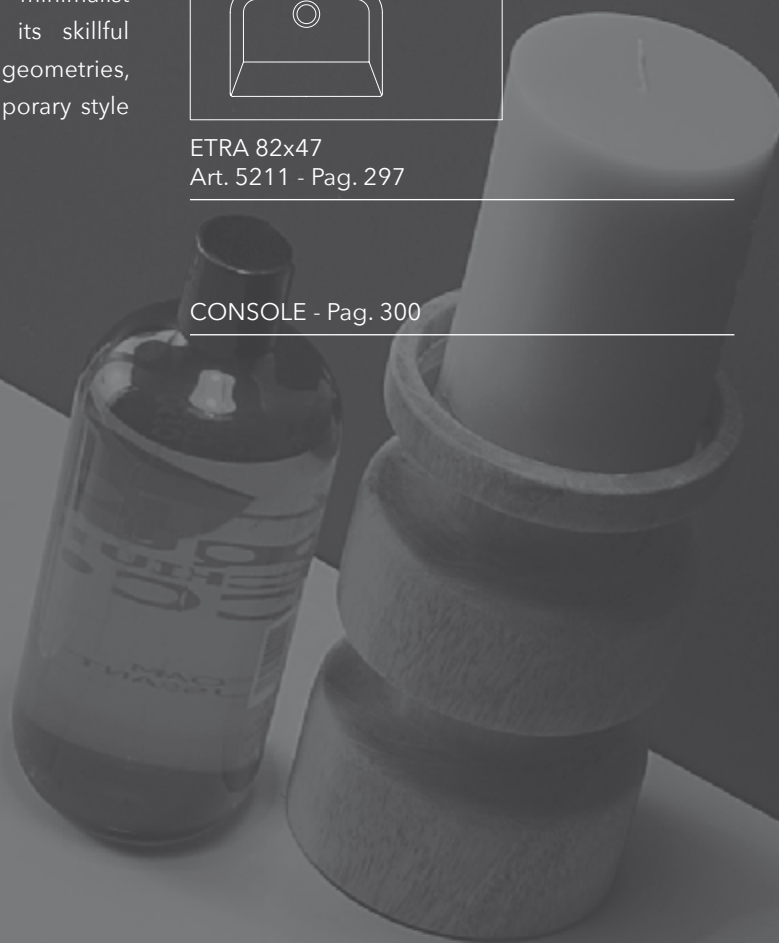

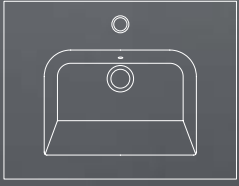

Art. 5210 - 61,5 x 47 x h13,5 cm
ETRA 61x47

Lavabo sospeso - Wall-mounted washbasin

Lavabo suspendu - Hängewaschbecken

Lavabo suspendido - Раковина умывальника подвесная



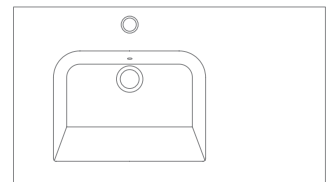

Art. 5211 - 82,5 x 47 x h13,5 cm

ETRA 82x47

Lavabo sospeso - Wall-mounted washbasin

Lavabo suspendu - Hängewaschbecken

Lavabo suspendido - Раковина умывальника подвесная







Consolle per lavabo - Console for washbasin - Console pour lavabo
Konsole für waschbecken - Consolle para lavabo - Подставка под раковину умывальника

Art. 10066 Per - For - Pour - Für - Para - Для: Art.: 5210

Art. 10067 Per - For - Pour - Für - Para - Для: Art.: 5211





Un design razionale ed essenziale esprime la ricerca della purezza delle forme. Da questo concetto lo studio Valeri ha progettato Seventy dalle linee semplici e chic.

A logical and basic design expresses our search for pure shapes. The Valeri studio used this as its main concept when designing Seventy, with its simple and chic lines.

DESIGN
STUDIO VALERI

41 cm



SEVENTY 41
Art. 8093 - Pag. 304



SEVENTY 41B
Art. 8093/B - Pag. 305

55 cm



SEVENTY 56
Art. 8094 - Pag. 304





Art. 8093 - 41 x 22 x h13,5 cm
SEVENTY 41

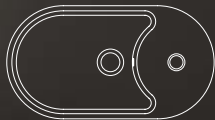

Art. 8094 - 55 x 30 x h13,5 cm
SEVENTY 56

Lavabo da appoggio - Lay-on washbasin
Lavabo à poser - Aufsatzwaschbecken
Lavabo de apoio - Раковина умывальника накладная





Art. 8093/B - 41 x 22 x h13,5 cm

SEVENTY 41/B

Lavabo sospeso DX - Wall-mounted washbasin RIGHT

Lavabo suspendu DROITE - Hängewaschbecken DX

Lavabo suspendido DERECHA - Раковина умывальника подвесная DX



41 cm



NEXT 40A BUILT-IN
Art. 8047/A - Pag. 308

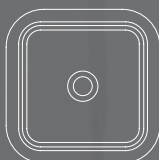

NEXT 40
Art. 8306 - Pag. 309



NEXT 40B
Art. 8047/B - Pag. 310

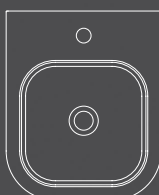

NEXT 40D
Art. 8047/D - Pag. 311

60-81,5 cm

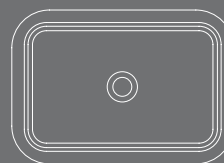

NEXT 60
Art. 8307 - Pag. 312

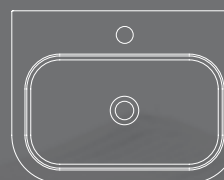

NEXT 60B
Art. 8308 - Pag. 313

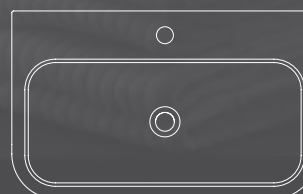

NEXT 80D
Art. 8047/D-80 - Pag. 315

Dall'aspetto semplice e dall'indiscussa funzionalità Next è la soluzione ideale per abitazioni in stile moderno ed informale. Un ritorno alle forme semplici ed essenziali per il lavabo disegnato da Giovanni Calisti per Scarabeo. Può essere montato ad appoggio, ad incasso o semincasso.

Due to its simple appearance and unquestioned functionality, Next is the ideal solution for homes furnished in a modern and informal style. This washbasin, designed by Giovanni Calisti for Scarabeo, marks a return to simple, fundamental shapes. It may be surface-mounted, recessed or semi-recessed.

DESIGN
GIOVANNI CALISTI

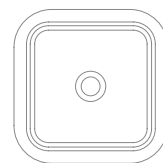

Art. 8047/A - 41 x 41 x h5,5 cm / total 13,5 cm
NEXT 40A

Lavabo da incasso - Built-in washbasin

Lavabo encastré - Einbauwaschbecken

Lavabo de encaje - Раковина умывальника встраиваемая

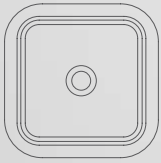

Art. 8306 - 41 x 41 x h13,5 cm

NEXT 40

Lavabo da appoggio - Lay-on washbasin

Lavabo à poser - Aufsatzwaschbecken

Lavabo de apoio - Раковина умывальника накладная



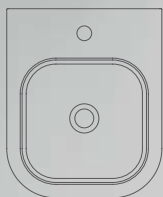

Art. 8047/B - 41 x 50 x h13,5 cm

NEXT 40B

Lavabo da appoggio o sospeso - Lay-on or wall-mounted washbasin

Lavabo à poser ou suspendu - Aufsatz-oder Hängewaschbecken

Lavabo de apoio o suspendido - Раковина умывальника накладная или подвесная

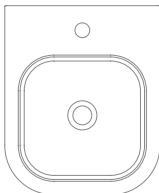

Art. 8047/D - 41 x 50 x h5 cm / total 13,5 cm
NEXT 40D

Lavabo da semincasso - Semi built-in washbasin

Lavabo semi encastré - Vorbauwaschbecken

Lavabo de semiencaixe - Раковина умывальника полувстраиваемая

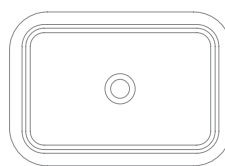

Art. 8307 - 60 x 41 x h13,5 cm
NEXT 60

Lavabo da appoggio - Lay-on washbasin

Lavabo à poser - Aufsatzwaschbecken

Lavabo de apoio - Раковина умывальника накладная

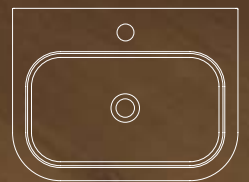

Art. 8308 - 60 x 46 x h13,5 cm
NEXT 60B

Lavabo da appoggio o sospeso - Lay-on or wall-mounted washbasin
Lavabo à poser ou suspendu - Aufsatz-oder Hängewaschbecken

Lavabo de apoio o suspenso - Раковина умывальника накладная или подвесная



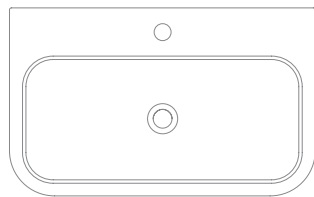

Art. 8047/D-80 - 81,5 x 51 x h5 cm / total 13,5 cm
NEXT 80D

Lavabo da semincasso - Semi built-in washbasin

Lavabo semi encastré - Vorbauwaschbecken

Lavabo de semiencasaje - Раковина умывальника полувстраиваемая



Fonte d'ispirazione la natura, dove l'armonia regna assoluta. Shape nasce per assomigliarvi: nell'eleganza delle sue forme morbide e sinuose.

Inspired by nature, where harmony reigns supreme. Shape was created to resemble its users: elegant in its soft and curved contours.

DESIGN
STUDIO VALERI

45 cm

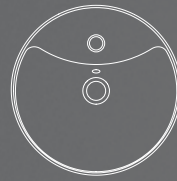

SHAPE 45
Art. 8098 - Pag. 318

70 cm

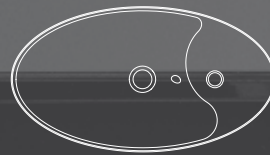

SHAPE 70x39
Art. 8097 - Pag. 320

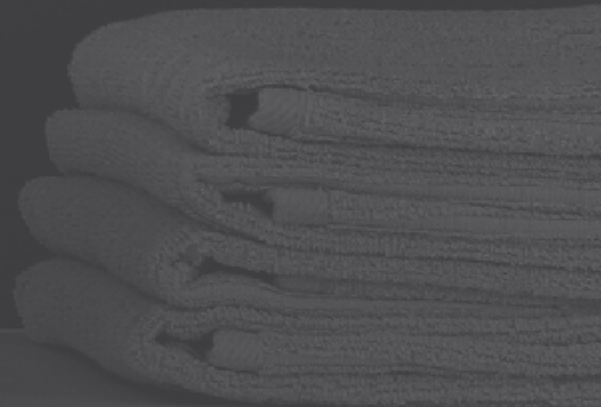

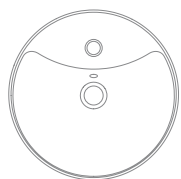

Art. 8098 - Ø45 x h12 cm

SHAPE 45

Lavabo da appoggio - Lay-on washbasin - Lavabo à poser

Aufsatzwaschbecken - Lavabo de apoio - Раковина умывальника накладная





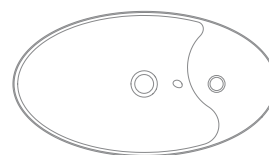

Art. 8097 - 70 x 39 x h13 cm
SHAPE 70x39

Lavabo da appoggio - Lay-on washbasin - Lavabo à poser
Aufsatzwaschbecken - Lavabo de apoio - Раковина умывальника накладная





LAVABI D'ARREDO

29,5-48 cm



IN-OUT 30
Art. 8020 - Pag. 324



GIOVE
Art. 8034 - Pag. 325



IN-OUT 40
Art. 8021 - Pag. 324

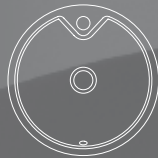

LUNA
Art. 8003 - Pag. 326

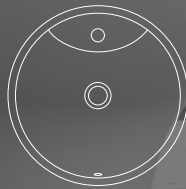

RONDO'
Art. 8008 - Pag. 327

49-87 cm

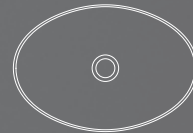

ZEFIRO 50
Art. 8207 - Pag. 328

DESIGN MASSIMILIANO BRACONI

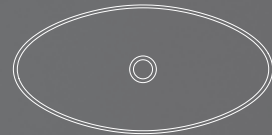

ZEFIRO 70
Art. 8206 - Pag. 328

DESIGN MASSIMILIANO BRACONI

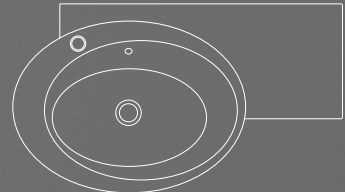

WISH SHELF DX
Art. 2011 - Pag. 331

DESIGN GIOVANNA TALOCCI

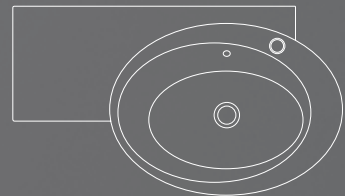

WISH SHELF SX
Art. 2012 - Pag. 331

DESIGN GIOVANNA TALOCCI

Disegnati da Giovanni Calisti per SCARABEO, il progetto Lavabi d'Arredo è una fonte ricca di soluzioni, che alterna lavabi da appoggio o da incasso. Collezione che si adatta ad arredare il bagno contemporaneo, caratterizzandolo con un segno forte e discreto allo stesso tempo.

Designed by Giovanni Calisti for SCARABEO, the Fitted Washbasin project is a rich font of solutions, which alternates supported basins with recessed basins. It is a collection which adapts itself to contemporary bathroom furnishings, stamping it with a strong yet discreet personality at the same time.

DESIGN
GIOVANNI CALISTI



WISH URINAL
Art. 2014 - Pag. 332



Art. 8020 - Ø29,5 H16 x h0,9 cm / total 16 cm
IN-OUT 30

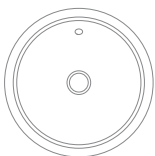

Art. 8021 - Ø39,5 x h1,5 cm / total 18 cm
IN-OUT 40

Lavabo da incasso - Built-in washbasin - Lavabo encastré
Einbauwaschbecken - Lavabo de encaje - Раковина умывальника встраиваемая



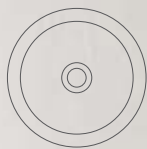

Art. 8034 - Ø37 x h15 cm

GIOVE

Lavabo da appoggio - Lay-on washbasin

Lavabo à poser - Aufsatzwaschbecken

Lavabo de apoio - Раковина умывальника накладная



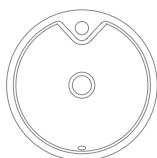

Art. 8003 - Ø40 x h16,5 cm

LUNA

Lavabo da appoggio - Lay-on washbasin - Lavabo à poser

Aufsatzwaschbecken - Lavabo de apoyo - Раковина умывальника накладная

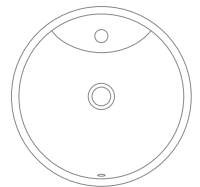

Art. 8008 - Ø48 x h4 cm / total 16,5 cm
RONDO'

Lavabo da incasso - Built-in washbasin - Lavabo encastré
Einbauwaschbecken - Lavabo de encaje - Раковина умывальника встраиваемая

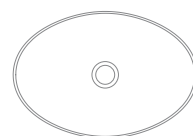

Art. 8207 - 49 x 36 x h18 cm
ZEFIRO 50



Art. 8206 - 68 x 36 x h16,5 cm
ZEFIRO 70

Lavabo da appoggio - Lay-on washbasin - Lavabo à poser
Aufsatzwaschbecken - Lavabo de apoio - Раковина умывальника накладная





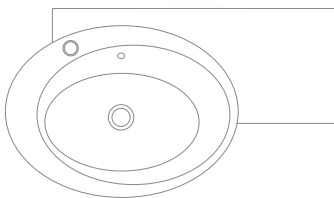

Art. 2011 - 87 x 52 x h13,5 cm
WISH SHELF DX

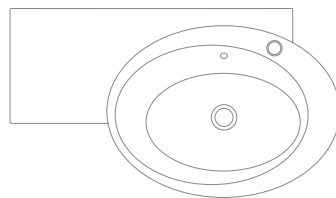

Art. 2012 - 87 x 52 x h13,5 cm
WISH SHELF SX

Lavabo da appoggio o sospeso - Lay-on or wall-mounted washbasin

Lavabo à poser ou suspendu - Aufsatz-oder Hängewaschbecken

Lavabo de apoio o suspenso - Раковина умывальника накладная или подвесная

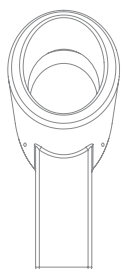

Art. 2014 - 28 x 30 x h69,5 cm

WISH URINAL

Urinatoio da parete - Wall-mounted urinal - Urinoir mural

Wand-Urinal - Urinario de pared - Писсуар напольный







Tra sperimentazione ed evoluzione, Scarabeo Ceramiche apre la strada verso un mercato inesplorato con il lavello da cucina in ceramica UP.

Up è un'innovazione ispirata alla tradizione, una proposta in contrasto con lo stile minimal delle cucine più diffuse che, allo stesso tempo, si sposa con esse, diventando l'oggetto decorativo della cucina, il protagonista della scena con un tocco unico e personale. Linee femminili e raffinate disegnano un bordo rialzato che delimita la zona lavaggio da quella di appoggio, mentre la fessura che interrompe questo segno armonico, è utile a far defluire l'acqua verso il centro del lavello.

Scarabeo Ceramiche is using trials and development to open the way to an unexplored market, with the UP ceramic kitchen sink. Up is an innovative product inspired by tradition, a proposal in contrast with the minimalist style of the most widely available kitchens, but also in harmony with them. It becomes a decorative element, the central focus offering a unique and personal touch. Feminine and refined lines form a raised edge between the sink and the surface area, and the gap which breaks up this harmonious line assists the water flow towards the centre of the sink.

EMO DESIGN



86 cm

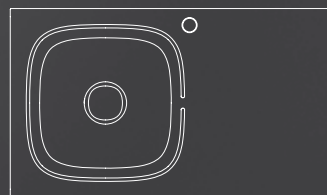

UP SHELF DX
Art. 1890 - Pag. 338

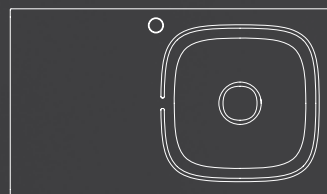

UP SHELF SX
Art. 1891 - Pag. 338





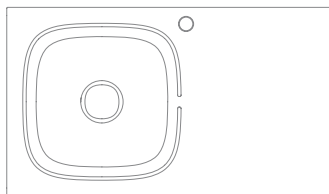

Art. 1890 - 86 x 50 x h7 cm / total 23 cm
UP SHELF DX

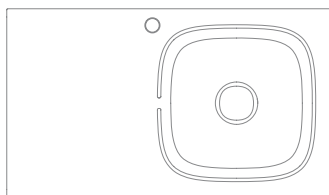

Art. 1891 - 86 x 50 x h7 cm / total 23 cm
UP SHELF SX

Lavello da cucina - Kitchen sink - Évier de cuisine
Spülbecken - Fregadero - Кухонная мойка



MOON

Sedile per Wc in termoindurente
 Seat cover Wc in termosetting resin
 Abattant wc en matière thermodurcissable
 WC-deckel Duroplas
 Asiento para inodoro en material termoenduracido
 Сиденье унитаза из термореактивного полимера



Sgancio rapido
 Rapid lift system
 Décrochage rapide
 Schnellbefestigung
 Desenganche rápido
 Быстрое отсоединение

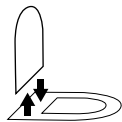

Per - For - Pour - Für - Para - Для:
 Art.: 5520/CL - 5520 - 5522/CL - 5526/CL

Art. 5530/A
 Con cerniere cromate
 With chromed Kit
 Charnières chromées
 Mit scharniere chrom
 Bisagras cromadas
 С хромированными шарнирами

Art. 5530/B
 Con cerniera rallentata
 With soft close system
 Charnieres avec frein de chute
 Mit sanft abgebremsten scharnieren
 Con caída amortiguada
 С микролифтом

MOON

Sedile per Wc in termoindurente
 Seat cover Wc in termosetting resin
 Abattant wc en matière thermodurcissable
 WC-deckel Duroplas
 Asiento para inodoro en material termoenduracido
 Сиденье унитаза из термореактивного полимера



Sgancio rapido
 Rapid lift system
 Décrochage rapide
 Schnellbefestigung
 Desenganche rápido
 Быстрое отсоединение

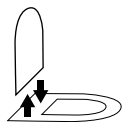

Per - For - Pour - Für - Para - Для:
 Art.: 5524/CL

Art. 5526/A
 Con cerniere cromate
 With chromed Kit
 Charnières chromées
 Mit scharniere chrom
 Bisagras cromadas
 С хромированными шарнирами

Art. 5526/B
 Con cerniera rallentata
 With soft close system
 Charnieres avec frein de chute
 Mit sanft abgebremsten scharnieren
 Con caída amortiguada
 С микролифтом

TEOREMA 2.0

Sedile per Wc in termoindurente
 Seat cover Wc in termosetting resin
 Abattant wc en matière thermodurcissable
 WC-deckel Duroplas
 Asiento para inodoro en material termoenduracido
 Сиденье унитаза из термореактивного полимера



Sgancio rapido
 Rapid lift system
 Décrochage rapide
 Schnellbefestigung
 Desenganche rápido
 Быстрое отсоединение

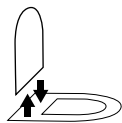

Per - For - Pour - Für - Para - Для:

Art. 8305/A
 Con cerniere cromate
 With chromed Kit
 Charnières chromées
 Mit scharniere chrom
 Bisagras cromadas
 С хромированными шарнирами

Art. 8305/B
 Con cerniera rallentata
 With soft close system
 Charnieres avec frein de chute
 Mit sanft abgebremsten scharnieren
 Con caída amortiguada
 С микролифтом

BUCKET

Sedile per Wc in termoindurente
 Seat cover Wc in termosetting resin
 Abattant wc en matière thermodurcissable
 WC-deckel Duroplas
 Asiento para inodoro en material termoenduracido
 Сиденье унитаза из термореактивного полимера



Sgancio rapido
 Rapid lift system
 Décrochage rapide
 Schnellbefestigung
 Desenganche rápido
 Быстрое отсоединение

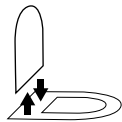

Per - For - Pour - Für - Para - Для:

Art. 8814/A
 Con cerniere cromate
 With chromed Kit
 Charnières chromées
 Mit scharniere chrom
 Bisagras cromadas
 С хромированными шарнирами

Art. 8814/B
 Con cerniera rallentata
 With soft close system
 Charnieres avec frein de chute
 Mit sanft abgebremsten scharnieren
 Con caída amortiguada
 С микролифтом



BUCKET

Sedile per Wc
Seat cover Wc
Abattant wc
WC-deckel
Asiento para inodoro
Сиденье унитаза

8816/A

Con cerniere cromate
With chromed Kit
Charnières chromées
Mit scharniere chrom
Bisagras cromadas
С хромированными шарнирами



PLANET

Sedile per Wc in termoidurente
Seat cover Wc in thermosetting resin
Abattant wc en matière thermodurcissable
WC-deckel Duroplas
Asiento para inodoro en material termoenduracido
Сиденье унитаза из термореактивного полимера

Art. 8108/A

Con cerniere cromate
With chromed Kit
Charnières chromées
Mit scharniere chrom
Bisagras cromadas
С хромированными шарнирами

Art. 8108/B

Con cerniera rallentata
With soft close system
Charnieres avec frein de chute
Mit sanft abgebremsten scharnieren
Con caída amortiguada
С микролифтом



MOAI

Sedile per Wc in termoidurente
Seat cover Wc in thermosetting resin
Abattant wc en matière thermodurcissable
WC-deckel Duroplas
Asiento para inodoro en material termoenduracido
Сиденье унитаза из термореактивного полимера

Art. 8609/A

Con cerniere cromate
With chromed Kit
Charnières chromées
Mit scharniere chrom
Bisagras cromadas
С хромированными шарнирами

Art. 8609/B

Con cerniera rallentata
With soft close system
Charnieres avec frein de chute
Mit sanft abgebremsten scharnieren
Con caída amortiguada
С микролифтом

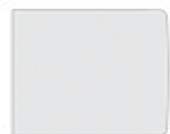

TEOREMA

Sedile per Wc in termoidurente
Seat cover Wc in thermosetting resin
Abattant wc en matière thermodurcissable
WC-deckel Duroplas
Asiento para inodoro en material termoenduracido
Сиденье унитаза из термореактивного полимера

Art. 8703/A

Con cerniere cromate
With chromed Kit
Charnières chromées
Mit scharniere chrom
Bisagras cromadas
С хромированными шарнирами

Art. 8703/B

Con cerniera rallentata
With soft close system
Charnieres avec frein de chute
Mit sanft abgebremsten scharnieren
Con caída amortiguada
С микролифтом

Sgancio rapido
Rapid lift system
Décrochage rapide
Schnellbefestigung
Desenganche rápido
Быстрое отсоединение

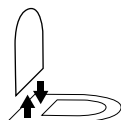

**Art. 10005**

Staffe di montaggio Wc e bidet
 Fixing attachments for Wc and bidet
 Supports de montage pour cuvette et bidets suspendus
 Montagebügel Für Hänge-wc und bidet
 Soportes de montaje inodoro y bidé
 Монтажные кронштейны для унитаза и биде

Art. 10050

Tassello per sanitari sospesi
 Dowel for wall-mounted sanitary ware
 Cheville pour WC suspendus
 Dübel für hängende Sanitäreinrichtungen
 Taco para sanitarios suspendidos
 Вкладыш для подвесной сантехники

Art. 10004/A

Cerniere cromate complete di kit fissaggio
 Chromed kit for seat cover
 Charnières avec kit de montage
 Scharniere komplett mit montagebausatz
 Bisagras cromadas con kit de fijación
 Хромированные шарниры в комплекте с крепежом

Art. 10004/B

Set cerniere rallentate di ricambio per coprivater complete di kit fissaggio
 Soft Closed System For Seat Cover
 Charnieres Avec Frein De Chute
 Mit Sanft Abgebremsten Scharnieren
 Juego de bisagras ralentizadas de repuesto para tapa de inodoro completas de kit de fijación
 Комплект запасных замедленных петель для крышки унитаза с крепежным комплектом

Art. 10030

Cartucce di ricambio per copri water soft closed
 Spare cylindrical parts for soft closed wc cover
 Amortisseurs de rechange pour abattant à descente retenue
 Ersatzkartuschen für toilettensitz mit absenkautomatik
 Piezas cilíndricas de repuesto para cubre tapa inodoro soft closed
 Сменные детали микролифта для крышки унитаза

**Art. 10012**

Distanziatore in ABS Cromato
 ABS spacer Chromed
 Entretoise en ABS chromé
 Distanzstück aus verchromtem ABS
 Separador de abs cromado
 Распорная шайба из хромированного пластика АБС

**Art. 10013**

Distanziatore in ottone Cromato
 Brass spacer Chromed
 Entretoise en laiton chromé
 Distanzstück aus verchromtem messing
 Separador de latón cromado
 Распорная шайба из хромированной латуни



Art. 10014

Curva tecnica per Wc
 Tecnical plastic curve for wc
 Pipe coudee pour cuvette
 wc-anschlussbogen
 Curva técnica para inodoro
 Колено сливное для унитаза

Art. 10022

Sistema di scarico per Art. 5527 / Art. 8312
 Flushing system for Art. 5527 / Art. 8312
 Système d'évacuation pour Art. 5527 / Art. 8312
 Ablaufsystem Für Art. 5527 / Art. 8312
 Sistema De Descarga Para Art. 5527 / Art. 8312
 Система слива для Art. 5527 / Art. 8312

ENTRATA ACQUA SOTTO A DESTRA DA 1/2"
 RIGHT HAND BOTTOM 1/2" INCH INLET
 ENTRÉE EAU EN BAS À DROITE 1/2 POUCE
 WASSEREINLAUF UNTEN RECHTS MIT 1/2 ZOLL
 ENTRADA DE AGUA INFERIOR DERECHA DE 1/2"
 ВХОД ВОДЫ СНИЗУ СПРАВА, 1/2"



Art. 10016

Sistema di scarico Geberit per Art. 8404 / Art. 2013
 Flushing system Geberit for Art. 8404 / Art. 2013
 Système d'évacuation geberit pour Art. 8404 / Art. 2013
 Geberit ablaufsystem Für Art. 8404 / Art. 2013
 Sistema De Descarga Geberit Para Art. 8404 / Art. 2013
 Система слива Geberit для Art. 8404 / Art. 2013

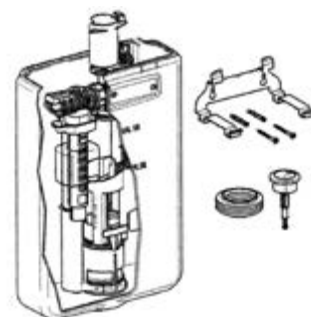

ENTRATA ACQUA SOTTO A DESTRA DA 1/2"
 RIGHT HAND BOTTOM 1/2" INCH INLET
 ENTRÉE EAU EN BAS À DROITE 1/2 POUCE
 WASSEREINLAUF UNTEN RECHTS MIT 1/2 ZOLL
 ENTRADA DE AGUA INFERIOR DERECHA DE 1/2"
 ВХОД ВОДЫ СНИЗУ СПРАВА, 1/2"



Art. 10010 - 10010/C

Scarico automatico - 1" 1/4 click-clack, tappo grande senza troppo pieno
 Automatic pop-waste - 1" 1/4 click-clack, big plug, without overflow
 Bonde clic-clac, grand debit sans trop-plein
 Automatischer ablauf click-clack, crosser stöpsel, ohne überlauf
 Valvula automática 1" 1/4 click-clack, tapón grande sin rebosadero
 Слив автоматический: клапан 1"1/4, большая пробка с защитой от переполнения



Art. 10011 - 10011/C

Scarico automatico 1" 1/4 click-clack, tappo grande
 Automatic pop-waste 1" 1/4 click-clack, big plug
 Bonde clic-clac, grand debit
 Automatischer ablauf click-clack, crosser stöpsel
 Valvula automática 1" 1/4 click-clack, tapón grande
 Слив автоматический: клапан 1"1/4, большая пробка



Art. 10026
 Piletta sempre aperta
 Waste always open
 Bonde toujours ouverte
 Immer offener Auslauf
 Pileta siempre abierta
 Сток всегда открыт



Art. 10021
 Scarico automatico 1" 1/4
 Automatic pop-waste 1" 1/4
 Bonde 1" 1/4
 Automatischer ablauf 1" 1/4
 Valvula automática 1" 1/4
 Слив автоматический 1" 1/4

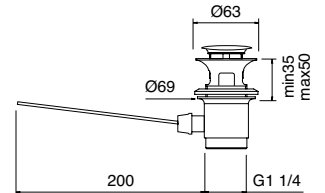

Art. 10007
 Sifone quadro in ottone 1" 1/4 cromato
 Cp Brass square trap 1" 1/4 chromed
 Syphon carré en laiton chromé
 Siphon aus verchromtem messing, viereckig
 Sifón cuadrado de latón 1" 1/4 cromado
 Сифон квадратного сечения 1" 1/4 из хромированной латуни

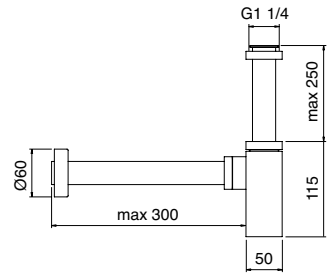

Art. 10008
 Sifone tondo in ottone 1" 1/4 cromato
 Cp Brass round trap 1" 1/4 chromed
 Syphon rond en laiton chromé
 Siphon aus verchromtem messing, rund
 Sifón redondo de latón 1" 1/4 cromado
 Сифон круглого сечения 1" 1/4 из хромированной латуни

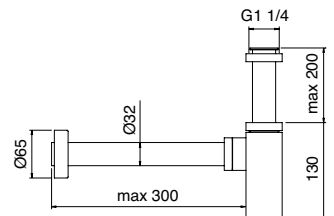

Art. 10009
 Sifone tondo in ottone ribassato 1" 1/4 cromato
 Cp Brass round trap, shorted 1" 1/4 chromed
 Syphon petit culot laiton chromé
 Siphon aus verchromtem messing, abgeflacht
 Sifón redondo de latón rebajado 1" 1/4 cromado
 Сифон круглого сечения 1" 1/4 укороченный, из хромированной латуни

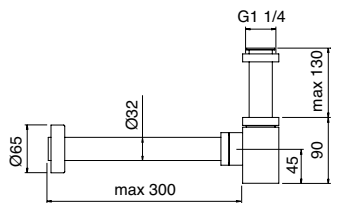

Art. 10019
 Sifone in ottone da 1" 1/4 per bidet
 Brass trap, 1" 1/4 chromed for bidet
 Syphon petit chromé 1" 1/4 pour bidet
 Siphon aus verchromtem 1" 1/4 für bidet
 Sifón de latón de 1" 1/4 para bidé
 Сифон латунный 1" 1/4 для биде

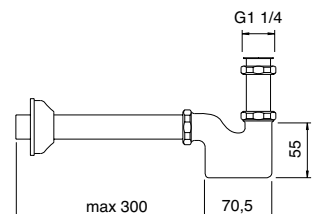

ECO WATER SAVING PLUS

La continua ricerca e lo sviluppo di nuovi prodotti con innovativi sistemi di scarico ha consentito la creazione di **ECO WATER SAVING PLUS**, grazie al quale i nostri Wc scaricano utilizzando **solo 2/4lt d'acqua**.

Continual research and development into new products with innovative flush systems has led to creation of **ECO WATER SAVING plus**, thanks to which our WCs **only use 2/4l water** for flushing.

La recherche continue et le développement de nouveaux produits dotés de systèmes d'évacuation novateurs ont permis la création d'**ECO WATER SAVING**, grâce auquel une chasse **n'utilise que 2 à 4 litres d'eau**.

Die konstante Erforschung und Entwicklung neuer Produkte mit innovativen Abflusssystemen ermöglichte die Kreation des Systems **ECO WATER SAVING Plus**, dank dem unsere WCs beim Spülen **nur 2 oder 4 Liter Wasser** verbrauchen.

La continua actividad de investigación y desarrollo de nuevos productos con innovadores sistemas de desagüe ha permitido la creación de **ECO WATER SAVING plus**, con el cual nuestros WC se descargan utilizando **sólo 2-4 litros de agua**.

Непрерывающиеся исследования и разработки новых изделий с применением инновационных систем слива открыли возможности для создания такой системы, как **ECO WATER SAVING plus**, благодаря использованию которой в наших унитазах при сливе используется только **2–4 л воды**.

Art.	DESCRIPTION	Geberit *	Tece	Oli *	Geberit **	Oli **	Grohe	Valsir
5520	MOON WALL-MOUNTED WC	2,5 lt		2,5 lt			2 lt	2 lt
5520/CL	MOON WALL-MOUNTED WC Clean Flush WC	2,5 lt	2,5 lt	2,5 lt			3 lt	
5522	MOON FLOOR-MOUNTED WC	2,8 lt	2,8 lt	2,8 lt				2 lt
5522/CL	MOON FLOOR-MOUNTED WC Clean Flush WC	2,8 lt	2,8 lt	2,8 lt				2 lt
5526/CL	MOON WC MONOBLOCK Clean Flush WC				3 lt	4 lt		
5524/CL	MOON WALL-MOUNTED WC Clean Flush WC	2,5 lt	2,5 lt	2,5 lt			3 lt	
8812	BUCKET WALL-MOUNTED WC	3 lt		3 lt			2 lt	2 lt
8812/CL	BUCKET WALL-MOUNTED WC Clean Flush WC	2,5 lt	2,5 lt	2,5 lt			2 lt	2 lt
5126/CL	TEOREMA 2.0 WALL-MOUNTED Clean Flush WC	3 lt	3 lt				3 lt	3 lt
5138/CL	TEOREMA 2.0 FLOOR-MOUNTED WC Clean Flush WC	3 lt	3 lt				3 lt	3 lt
5140/CL	TEOREMA 2.0 WC MONOBLOCK Clean Flush WC				3 lt	4 lt		
8701	TEOREMA WALL-MOUNTED WC	2,5 lt	2,5 lt				2 lt	2 lt
8105	PLANET WALL-MOUNTED WC	3 lt		3 lt			2 lt	2 lt
8105/CL	PLANET WALL-MOUNTED WC Clean Flush WC	3 lt	3 lt	3 lt			2 lt	2 lt
8401	PLANET FLOOR-MOUNTED WC	3 lt		3 lt			2 lt	2 lt

Geberit * = Art. 111.907.00.5 Duofix Sigma 12 / Art. 111.907.00.1 Duofix Sigma 8 - UNI EN 997 CL2

Tece = Art. 9.370.007 Tece Box - UNI EN 997 CL2

Oli * = Art. OL0601881 OLI74 PLUS - UNI EN 997 CL2

Geberit ** = Art. 273.401.21.1 DUAL BC 3/8 - UNI EN 997 CL2

Oli ** = Art. OL0501124 ATLAS/AZOR ATT.BASSO 3/8 - UNI EN 997 CL2

Grohe = Art. 38661000 - UNI EN 997 CL2

Valsir = Art. T-VSO858002 - UNI EN 997 CL2

NOTA BENE

1) Il sistema di scarico piletta deve sempre essere ancorato al lavabo pertanto il foro consigliato da praticare sul top dove vengono appoggiati i lavabi deve avere un diametro necessario a consentire tale operazione. Per i nostri prodotti si prega di ricavare le dovute dimensioni dei fori da praticare sui top dalla sezione Caratteristiche tecniche del catalogo generale.

2) Il diametro del foro consigliato da praticare sul top per il passaggio delle connessioni dell'acqua al rubinetto deve essere non inferiore a 40 mm di diametro. Si prega di controllare prima di praticare il foro anche la scheda tecnica del rubinetto che viene utilizzato.

* **Specifica Certificazioni e conformità alla norma UNI EN 997 - 14528 riguardante lo scarico dei WC e bidet relativa marchiatura CE.** La documentazione completa è disponibile a richiesta presso i nostri uffici.

NOTE

1) The plughole drainage system must always be fixed to the washbasin; it is therefore recommended that the holes made in the tops on which the washbasins are mounted have a diameter large enough to accommodate this. As far as our products are concerned, please refer to the Technical Characteristics section of the General Catalogue to obtain details of the specific measurements necessary for the holes made in the tops.

2) The minimum recommended diameter of the hole to be made in the top for the passage of the water connections to the tap is 40 mm. Please make sure you also check the technical specification of the tap used before making the hole.

* **Specification outlining certifications and conformity with standard UNI EN 997 - 14528 (relating to WC waste pipes and bidet) and corresponding CE branding.**

The complete documentation is available from our offices on request.

REMARQUE

1) La bonde d'écoulement doit toujours être fixée au lavabo. Pour effectuer cette opération, il est donc recommandé de découper sur le plan une ouverture du diamètre prévu pour le lavabo. À la section Caractéristiques techniques de notre catalogue général, vous pourrez trouver les dimensions requises pour les ouvertures à réaliser sur les plans.

2) Il est conseillé de percer un trou pour le passage des raccords de l'arrivée d'eau au robinet d'un diamètre d'au moins 40 mm. Veuillez à vérifier les cotes de l'orifice précisées sur la fiche technique du robinet utilisé.

* **Caractéristiques techniques et certificat de conformité (UNI EN 997 - 14528) pour la décharge des WC et bidet et label CE.**

La documentation complète est disponible sur demande en nos bureaux.

HINWEIS

1) Das Abflusssystem muss immer am Waschbecken befestigt werden, daher sollte die Bohrung im Top, auf dem die Waschbecken gestellt werden, einen ausreichenden Durchmesser haben, um den Anschluss auszuführen. Die notwendigen Durchmesser der Bohrungen im Top für unsere Produkte entnehmen Sie bitte dem Abschnitt Technische Eigenschaften in unserem Katalog.

2) Die im Top für die Durchleitung der Wasseranschlüsse benötigte Bohrung darf nicht weniger als 40 mm Durchmesser aufweisen. Bitte prüfen Sie, bevor sie das Loch bohren, auch das Datenblatt des Wasserhahns, der installiert wird.

* **Zertifizierung und Konformität mit der Norm UNI EN 997 - 14528 bezüglich der WC-Abflüsse und bidet und entsprechende CE-Kennzeichnung.**

Die komplette Dokumentation kann in unseren Büros angefordert werden.

ADVERTENCIA

1) El sistema de desagüe del sumidero debe estar siempre anclado al lavabo; por tanto, se aconseja efectuar en la encimera donde se apoyarán los lavabos un orificio con el diámetro suficiente para que pueda efectuarse esa operación. En el caso de nuestros productos, las medidas de los orificios que se han de practicar se encuentran en el apartado "Características técnicas" del Catálogo general.

2) En la encimera, para pasar las conexiones de agua al grifo, se practicará un orificio de diámetro no inferior a 40 mm. Antes de perforar, consúltese la ficha técnica del grifo que se ha de utilizar.

* **Especificación de certificaciones y conformidad con la norma UNI EN 997 relativa a la descarga del inodoro y a la correspondiente marca CE** La documentación completa está a disposición en nuestras oficinas.

ВАЖНАЯ ИНФОРМАЦИЯ

1) Система слива с пробкой должна всегда быть закреплена на раковине умывальника, в связи с чем рекомендуется, чтобы отверстие в столешнице, на которую должна опираться раковина умывальника, имело достаточно большой диаметр, обеспечивающий выполнение этой операции. Что касается нашей продукции, см. раздел «Технические характеристики» основного каталога, где приведены соответствующие размеры отверстий, выполняемых в столешнице.

2) Рекомендуемый размер отверстия в столешнице для прохождения соединительных шлангов подачи воды в кран должен составлять не менее 40 мм в диаметре. Прежде чем делать отверстие, рекомендуется свериться с техническими данными крана, который будет использоваться.

* **Технические условия на сертификацию и соответствие требованиям UNI EN 997–14528 в отношении слива унитаза и биде по маркировке CE.**

Полная документация доступна по запросу в офисах нашей компании.

* Norm UNI EN 997 - 14528

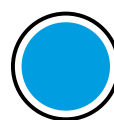
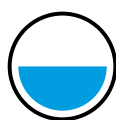

Art.	DESCRIPTION	3lt	4lt	4,5lt	5lt	6lt
5520	MOON WALL-MOUNTED WC	✓	✓	✓	✓	✓
5520/CL	MOON WALL-MOUNTED WC Clean Flush WC	✓	✓	✓	✓	✓
5522	MOON FLOOR-MOUNTED WC	✓	✓	✓	✓	✓
5522/CL	MOON FLOOR-MOUNTED WC Clean Flush WC	✓	✓	✓	✓	✓
5526/CL	MOON WC MONOBLOCK Clean Flush WC	✓	✓	✓	✓	✓
5524/CL	MOON WALL-MOUNTED WC Clean Flush WC	✓	✓	✓	✓	✓
5521	MOON WALL-MOUNTED BIDET	CL 25				
5523	MOON FLOOR-MOUNTED BIDET	CL 25				
5525	MOON WALL-MOUNTED BIDET	CL 25				
8812	BUCKET WALL-MOUNTED WC	✓	✓	✓	✓	✓
8812/CL	BUCKET WALL-MOUNTED WC Clean Flush WC	✓	✓	✓	✓	✓
8815	BUCKET WALL-MOUNTED WC KIDS	✓	✗	✓	✓	✓
8813	BUCKET WALL-MOUNTED BIDET	CL 25				
5126/CL	TEOREMA 2.0 WALL-MOUNTED Clean Flush WC	✓	✓	✓	✓	✓
5138/CL	TEOREMA 2.0 FLOOR-MOUNTED WC Clean Flush WC	✓	✓	✓	✓	✓
5140/CL	TEOREMA 2.0 WC MONOBLOCK Clean Flush WC	✓	✓	✓	✓	✓
5127	TEOREMA 2.0 WALL-MOUNTED BIDET	CL 25				
5139	TEOREMA 2.0 FLOOR-MOUNTED BIDET	CL 25				
8701	TEOREMA WALL-MOUNTED WC	✓	✓	✓	✓	✓
8702	TEOREMA WALL-MOUNTED BIDET	CL 25				
8105	PLANET WALL-MOUNTED WC	✓	✓	✓	✓	✓
8105/CL	PLANET WALL-MOUNTED WC Clean Flush WC	✓	✓	✓	✓	✓
8401	PLANET FLOOR-MOUNTED WC	✓	✓	✓	✓	✓
8106	PLANET WALL-MOUNTED BIDET	CL 25				
8403	PLANET FLOOR-MOUNTED BIDET	CL 25				
8604	MOAI WALL-MOUNTED WC	✓	✓	✓	✓	✓
8606	MOAI FLOOR-MOUNTED WC	✓	✓	✓	✓	✓
8605	MOAI WALL-MOUNTED BIDET	CL 25				
8607	MOAI FLOOR-MOUNTED BIDET	CL 25				

IT) Consigli per la pulizia e la manutenzione del bagno

Tutti i nostri prodotti, realizzati con materiali selezionati e sottoposti a tutti i controlli qualità, sono stati concepiti per durare a lungo nel tempo. Eventuali piccole alterazioni di colore o tono che si possono riscontrare tra gli oggetti sono sinonimo di produzione manuale, non industriale e garantiscono l'unicità del prodotto. Sono pertanto da considerare come caratteristiche di pregio e non difetti oggetto di contestazione. Un'accurata manutenzione ed alcuni piccoli accorgimenti permetteranno di conservare i sanitari sempre come nuovi, mantenendo intatte quelle caratteristiche estetiche e funzionali che determinano l'unicità e l'artigianalità dei prodotti Scarabeo.

Il nostro consiglio è di utilizzare sempre una spugna morbida per la pulizia dei lavabi e sanitari e di evitare l'uso di sostanze abrasive, caustiche o aggressive che possono rovinare od opacizzare la ceramica. Per un'igiene più sicura e per rimuovere gli eventuali residui di calcare o di sapone è consigliabile procedere periodicamente ad una pulizia più approfondita utilizzando sempre e comunque un detergente non abrasivo. Un regolare lavaggio con acqua tiepida e sapone, avendo cura di asciugare le superfici con un panno morbido subito dopo l'uso ed una particolare attenzione a non usare oggetti appuntiti o particolarmente ruvidi, saranno sufficienti per mantenere in perfette condizioni il nostro prodotto nel vostro bagno.

EN) Advice on bathroom cleaning and maintenance

All our products are manufactured with carefully selected materials, undergo strict quality controls and are designed to last. The minor alterations in colour or shade of the various items are the result of manual and not industrial production and guarantee a unique product. They should therefore be considered as precious features and not defects to complain about. Careful maintenance and several simple actions ensure that sanitary ware remains as good as new and retains the visual and functional features that guarantee the uniqueness and craftsmanship of Scarabeo products.

We suggest always using a damp sponge to clean the washbasins and sanitary ware. Avoid using abrasive, caustic or aggressive products that could damage or dull the ceramic. To ensure perfect hygiene and remove any traces of limescale or soap, it is recommended to clean them thoroughly every now and then, although again using a non-abrasive detergent. Wash our bathroom products regularly with warm water and soap and dry the surfaces thoroughly with a soft cloth after use, and also avoid using sharp or particularly rough objects, to ensure they remain in perfect condition.

FR) Conseils pour le nettoyage et l'entretien de la salle de bain

Tous nos produits sont réalisés à l'aide de matériaux triés sur le volet et soumis à tous les contrôles de qualité nécessaires. Ils ont été conçus afin de résister à l'épreuve du temps. Les petites altérations de couleur ou de ton qui peuvent apparaître sont le résultat d'un processus de production à la main, non industriel. Elles garantissent le caractère unique du produit. Ce sont donc des critères de luxe et ne sont en aucun cas des défauts pouvant faire l'objet d'une réclamation. Un entretien minutieux et le respect de plusieurs conseils vous permettront de préserver votre salle de bain et tous les aspects esthétiques et fonctionnels qui confèrent aux produits Scarabeo leur caractère unique et artisanal.

Nous vous conseillons donc d'utiliser toujours une éponge douce pour nettoyer les lavabos et les sanitaires. Evitez les produits abrasifs, caustiques ou agressifs qui pourraient endommager ou matifier la céramique. Pour un nettoyage en toute sécurité et pour éliminer les traces de calcaire ou de savon, procédez à un nettoyage plus approfondi à l'aide d'un détergent non abrasif en toutes circonstances. Effectuez un lavage régulier à l'eau tiède et au savon, en veillant à sécher les surfaces à l'aide d'un chiffon doux directement après utilisation. Veillez à ne pas utiliser d'objets pointus ou rugueux. Vous pourrez ainsi garantir l'état de nos produits et de votre salle de bain.

DE) Empfehlungen für die Reinigung und Instandhaltung des Bades

Alle unsere Produkte sind auf Langlebigkeit ausgelegt, da sie nur aus sorgfältig ausgewählten Materialien hergestellt und strengen Qualitätskontrollen unterzogen werden. Eventuelle geringfügige Farbtonabweichungen zwischen den einzelnen Produkten sind Merkmale der handwerklichen Verarbeitung und garantieren deren Einzigartigkeit. Daher sind solche Abweichungen Qualitätsmerkmale und stellen keine Mängel dar, die Gegenstand von Reklamationen sein könnten. Bei korrekter Pflege und richtiger Behandlung bleiben Ihre Sanitärprodukte über lange Zeit in einem einwandfreien Zustand und erhalten die ästhetischen und funktionellen Eigenschaften, die für die Einzigartigkeit und handwerkliche Verarbeitung der Produkte von Scarabeo charakteristisch sind. Wir empfehlen die Reinigung der Waschbecken und Sanitärprodukte mit einem weichen Schwamm. Vermeiden Sie bitte den Einsatz von Scheuermitteln, ätzenden oder auf sonstige Weise aggressiven Substanzen, die die Oberflächen der Keramik beschädigen oder ihren Glanz beeinträchtigen können. Für eine sichere Hygiene und zur Entfernung von Kalkablagerungen oder Seifenresten empfehlen wir, regelmäßig eine gründlichere Reinigung mit einem grundsätzlich nicht scheuernden Reinigungsmittel durchzuführen. Regelmäßiges Spülen mit lauwarmem Wasser und Seife, nachfolgendes Trocknen mit einem weichen Tuch und das Vermeiden von Kontakt mit spitzen oder sehr rauen Gegenständen ist völlig ausreichend, um die Sanitärprodukte in Ihrem Bad in einem perfekten Zustand zu erhalten.

ES) Consejos para la limpieza y el mantenimiento del baño

Todos nuestros productos, realizados con materiales seleccionados y sometidos a todos los controles de calidad, han sido diseñados para durar a lo largo del tiempo. Es posible que se produzcan pequeñas alteraciones del color o del tono, características de la elaboración manual, no industrial, garantía del carácter único del producto. Por eso deben considerarse características de valor y no defectos de fabricación a reclamar. El mantenimiento preciso y algunas pequeñas precauciones permiten mantener los sanitarios como nuevos, sin que se alteren las características estéticas y funcionales que los hacen únicos y aseguran el carácter artesanal de los productos Scarabeo. Nuestro consejo es utilizar siempre una esponja suave para la limpieza de los lavabos y sanitarios y evitar el uso de sustancias abrasivas, cáusticas o agresivas que podrían aruinar la cerámica y quitarle brillo. Para una higiene más segura y para quitar posibles residuos calcáreos o de jabón se aconseja periódicamente realizar una limpieza más profunda empleando un detergente no abrasivo. Un lavado frecuente con agua tibia y jabón, teniendo cuidado de secar las superficies con un paño blando inmediatamente después del uso, sin utilizar objetos puntiagudos o ásperos, será suficiente para mantener el sanitario en perfectas condiciones.

RU) Рекомендации по очистке и уходу за ванной комнатой

Все наши товары, выполненные из тщательно отобранных материалов, прошедших весь необходимый контроль качества, были разработаны таким образом, чтобы обеспечить длительный срок эксплуатации. Небольшие отклонения цвета или тона, которые, возможно, Вы встретите, являются следствием того, что товары не были произведены в серийном производстве, но являются результатом ручной работы, и свидетельствуют об их уникальности. Поэтому они должны рассматриваться как ценные характеристики, а не дефекты, являющиеся поводом для рекламации. Благодаря тщательному уходу и соблюдению некоторых несложных мер предосторожности, Ваши сантехнические изделия всегда будут как новые, и сохранятся эстетические и эксплуатационные характеристики, которые определяют уникальность и самобытность, присущие товарам компании Scarabeo. Рекомендуем Вам при очистке умывальников и сантехнических изделий всегда использовать мягкую губку и не прибегать к использованию абразивных, едких или агрессивных веществ, которые могут нанести вред керамическим изделиям или привести к помутнению их покрытия. Для обеспечения более строгой гигиены, а также для удаления возможных остатков известковых отложений или мыла рекомендуется периодически выполнять углубленную очистку, всегда используя для этого неабразивное чистящее средство. С тем, чтобы наши сантехнические товары, которые Вы выбрали для ванной комнаты, сохранили свое прекрасное состояние, будет достаточно регулярной мойки теплой водой с мылом и аккуратной протирки поверхностей мягкой тканевой салфеткой сразу же после использования. Необходимо также тщательно следить за тем, что Вы не используете заостренные или очень шероховатые предметы.



Hand made in Italy

SCARABEO CERAMICHE s.r.l.
Linea arredo bagno
Loc. Pian Del Trullo - 01034 Fabrica Di Roma - VT
Tel. 0039.0761.540028 - Fax 0039.0761.540286
www.scarabeosrl.com - info@scarabeosrl.com





Follow us on Instagram



<https://involgia.com>



info@involgia.com